

**EUROCONTROL STANDARD DOCUMENT**

**FOR**

**SURVEILLANCE DATA EXCHANGE**

**Part 21: Category 007**

**Transmission of  
Directed Interrogation Messages**

**SUR.ET1.ST05.2000-STD-21-01**

<b>Edition</b>	<b>:</b>	<b>1.4</b>
<b>Edition Date</b>	<b>:</b>	<b>June 2011</b>
<b>Status</b>	<b>:</b>	<b>Released Issue</b>
<b>Class</b>	<b>:</b>	<b>General Public</b>

# DOCUMENT IDENTIFICATION SHEET

## DOCUMENT DESCRIPTION

### Document Title

Surveillance Data Exchange - Part 21  
Transmission of Directed Interrogation Messages

EWP DELIVERABLE REFERENCE NUMBER

### PROGRAMME REFERENCE INDEX

SUR.ET1.ST05.2000-STD-21-01

EDITION :

1.4

EDITION DATE :

June 2011

### Abstract

This document describes the application of ASTERIX to the transmission of Directed Interrogation requests and the corresponding target response.

Category 007 describes data items necessary for the realisation of the Directed Interrogation functionality in radar stations.

### Keywords

Monoradar Data  
Data Item

ASTERIX  
Category 007

UAP  
Directed Interrogation

Target Reports

**CONTACT PERSON :** A. Engel

**TEL :** +32-2-729 3355

**UNIT :** DSS/REG/SES

## DOCUMENT STATUS AND TYPE

STATUS	CATEGORY	CLASSIFICATION
Working Draft <input type="checkbox"/>	Executive Task <input type="checkbox"/>	General Public <input checked="" type="checkbox"/>
Draft <input type="checkbox"/>	Specialist Task <input type="checkbox"/>	EATMP <input type="checkbox"/>
Proposed Issue <input type="checkbox"/>	Lower Layer Task <input checked="" type="checkbox"/>	Restricted <input type="checkbox"/>
Released Issue <input checked="" type="checkbox"/>		

## ELECTRONIC BACKUP

**INTERNAL REFERENCE NAME :** Asterix - Part 21

HOST SYSTEM	MEDIA	SOFTWARE(S)
Microsoft Windows	Type : Hard disk	
	Media Identification :	

### DOCUMENT APPROVAL

The following table identifies all management authorities who have successively approved the present issue of this document.

AUTHORITY	NAME AND SIGNATURE	DATE
ASTERIX Manager	D. Doukas	
SES Unit Manager	P. Green	
SURT Chairman		
DSS Director	L. Tytgat	

## DOCUMENT CHANGE RECORD

The following table records the complete history of the successive editions of the present document.

<b>EDITION</b>	<b>DATE</b>	<b>REASON FOR CHANGE</b>	<b>SECTIONS PAGES AFFECTED</b>
0.1	March 2007	Creation of new document from cat048 specification plus information on Directed Interrogations	ALL
0.2	May 2007	Message Types and UAPs updated	
0.3	June 2007	Footnote removed Status changed to "Proposed Issue" Note 5, Item I007/420 updated Subfield #2, I007/450 corrected UAP for "Uplink"-messages corrected Item I007/420 removed from message type 8 Chapter 6.1 adapted accordingly	Page 2  5.2.31 5.2.34 5.3.2  6.7 6.1
0.4	July 2007	Definition of "Reserved Expansion Field" (Mode 5 etc.) from category 048 integrated as item I007/085	5.2.13
0.5	August 2007	Item I007/415 Redesigned Item I007/430 Removed	5.2.31 5.2.33
1.0P	October 2007	Titlepage updated Signature Page updated Status "Proposed Released Edition"	
1.0	March 2008	Heading of chapter 5 modified Introduction to chapter 5 updated Chapter 6.4 corrected Heading of chapter 7 modified Item I007/400 updated Item I007/410 updated Note 4 to I007/410 updated Item I007/415 revised Item I007/450 revised	5 5.1 6.4 7 5.2.29 5.2.30 5.2.30 5.2.31 5.2.34
1.1	March 2009	Reference Document 2 updated SI/II Indication added to I007/230	2.2 5.2.25
1.2	September 2009	Corrections in Item I007/415 - Inclusion of FX bit in the Primary Subfield. - Encoding rule brought in line with the table in chapter 6.7	5.2.3.1
1.3	September 2010	Administrative pages updated UAP-entry for item I007/440 corrected	ii, iii Page 65
1.4	June 2011	Signature Page updated Abbreviations list updated I007/020: Note added (alignment to cat. 048) I007/030: codes 19-23 added (align. to cat. 048) I007/085: reference to M5N in REF added	iii 6 5.2.2 5.2.3 5.2.13

---

**TABLE OF CONTENTS**

**DOCUMENT IDENTIFICATION SHEET..... ii**

**DOCUMENT APPROVAL..... iii**

**DOCUMENT CHANGE RECORD..... iv**

**1. INTRODUCTION ..... 1**

**1.1 Introduction..... 1**

**1.2 Scope..... 1**

1.2.1 Procedure ..... 1

1.2.2 ASTERIX Category ..... 1

1.2.3 Implementation Issues ..... 1

**2. REFERENCES ..... 3**

**2.1 General ..... 3**

**2.2 Reference Documents ..... 3**

**3. DEFINITIONS, ACRONYMS AND ABBREVIATIONS ..... 5**

**3.1 Definitions ..... 5**

**3.2 Acronyms and Abbreviations ..... 6**

**4. GENERAL PRINCIPLES..... 9**

**4.1 General ..... 9**

**4.2 Time Management ..... 9**

4.2.1 Definition ..... 9

4.2.2 Requirements for Time Stamping ..... 9

**4.3 Projection Systems and Geographical Co-ordinates ..... 9**

4.3.1 Measured Position ..... 9

4.3.2 Calculated Position ..... 9

**4.4 Unused Bits in Data Items..... 10**

**4.5 Definitions and Addressing Concepts ..... 10**

4.5.1 Radar Sensor ..... 10

4.5.2 Radar System..... 10

4.5.3 Combination of Target Reports ..... 11

4.5.4 Addressing Concepts: Assigning SAC/SIC Codes ..... 11

**4.6 Radar Target Reports ..... 12**

4.6.1 Types of Radar Target Reports..... 12

4.6.2 User Application Profile and Data Blocks ..... 12

**4.7 Composition of Messages ..... 12**

**5. LAYOUT OF CAtegory 007 MESSAGES ..... 13**

**5.1 Standard Data Items ..... 13**

**5.2 Description of Standard Data Items ..... 14**

---

5.2.1	Data Item I007/010, Data Source Identifier .....	14
5.2.2	Data Item I007/020, Target Report Descriptor .....	15
5.2.3	Data Item I007/025, Data Destination Identifier.....	17
5.2.4	Data Item I007/030, Warning/Error Conditions.....	18
5.2.5	Data Item I007/040, Measured Position in Polar Co-ordinates.....	19
5.2.6	Data Item I007/042, Calculated Position in Cartesian Co-ordinates .....	20
5.2.7	Data Item I007/050, Mode-2 Code in Octal Representation.....	21
5.2.8	Data Item I007/055, Mode-1 Code in Octal Representation.....	22
5.2.9	Data Item I007/060, Mode-2 Code Confidence Indicator.....	23
5.2.10	Data Item I007/065, Mode-1 Code Confidence Indicator.....	23
5.2.11	Data Item I007/070, Mode-3/A Code in Octal Representation.....	24
5.2.12	Data Item I007/080, Mode-3/A Code Confidence Indicator .....	25
5.2.13	Data Item I007/085, Mode 5, Extended Mode 1 and X-Pulse.....	26
5.2.14	Data Item I007/090, Flight Level in Binary Representation.....	35
5.2.15	Data Item I007/100, Mode-C Code and Code Confidence Indicator.....	36
5.2.16	Data Item I007/110, Height Measured by a 3D Radar.....	37
5.2.17	Data Item I007/120, Radial Doppler Speed.....	38
5.2.18	Data Item I007/130, Radar Plot Characteristics .....	40
5.2.19	Data Item I007/140, Time of Day .....	43
5.2.20	Data Item I007/161, Track Number.....	43
5.2.21	Data Item I007/170, Track Status .....	44
5.2.22	Data Item I007/200, Calculated Track Velocity in Polar Co-ordinates .....	46
5.2.23	Data Item I007/210, Track Quality .....	47
5.2.24	Data Item I007/220, Aircraft Address .....	48
5.2.25	Data Item I007/230, Communications/ACAS Capability and Flight Status .....	49
5.2.26	Data Item I007/240, Aircraft Identification .....	50
5.2.27	Data Item I007/250, Mode S MB Data .....	51
5.2.28	Data Item I007/260, ACAS Resolution Advisory Report.....	52
5.2.29	Data Item I007/400, Directed Interrogation Request Number.....	53
5.2.30	Data Item I007/410, Directed Interrogation Message Type .....	54
5.2.31	Data Item I007/415, Required Interrogation Modes.....	55
5.2.32	Data Item I007/420, Directed Interrogation Window.....	58
5.2.33	Data Item I007/440, Directed Interrogation BDS Register Request.....	59
5.2.34	Data Item I007/450, Directed Interrogation Result .....	60
<b>5.3</b>	<b>Transmission of Surveillance Information.....</b>	<b>63</b>
5.3.1	Standard User Application Profile “Downlink” .....	63
5.3.2	Standard User Application Profile “Uplink” .....	65
<b>6.</b>	<b>Encoding Rules for Directed Interrogation Messages .....</b>	<b>66</b>
<b>6.1</b>	<b>Directed Position Interrogation (A) – Message Type 5.....</b>	<b>66</b>
<b>6.2</b>	<b>Directed Interrogation Window (B) – Message Type 6.....</b>	<b>67</b>
<b>6.3</b>	<b>Directed Track-Number Interrogation (C) – Message Type 7.....</b>	<b>67</b>
<b>6.4</b>	<b>Selective BDS-Request – Message Type 8 .....</b>	<b>67</b>

---

---

6.5	Reasons for Ambiguous Acknowledge.....	68
6.6	Limit for number of Directed Interrogation Requests .....	68
6.7	Summary .....	69
7.	Implementation example .....	70
7.1	General .....	70
7.2	Interrogation Requests.....	70
7.3	Interrogation Acknowledges.....	70
7.4	Interrogation Finished.....	71
7.5	Interrogation Completed .....	71
7.6	Protocol visualized .....	72

This page is intentionally left blank



## 1. INTRODUCTION

### 1.1 Introduction

The objective of this document is to propose a solution for the remote commanding of Directed Interrogations for secondary radar sensors (further on referred to as "sensor"). Directed Interrogations in the field of IFF/ATC applications are event driven communication between the secondary radar and the transponder in the aircraft that are commanded via a network by some e.g. cluster controller, multi sensor tracker, combat management system or air traffic controller (further on referred to as "client"). The commanding client requests a single interrogation from the sensor to gather specific information. The goal is to provide not only selective interrogations with Mode S (where it is natural) but with all possible Mode combinations (Mode Interlace Pattern). The Directed Interrogations are executed, based on the sensor external intelligence of the client, which maintains the track information. Especially for military purposes it is important to provide such a possibility for selective identification. The proposed solution is based on the EUROCONTROL standard ASTERIX protocol.

### 1.2 Scope

#### 1.2.1 Procedure

The following document defines a new ASTERIX Category 007 for the implementation of Directed Interrogation.

The specified ASTERIX Category 007 defines a data-format used bi-directionally between the commanding client and the sensor to implement the directed interrogation and reception of acknowledgements and status reports.

During "standard" surveillance operation of the sensor, no changes in behaviour will be observed. The sensor will generate ASTERIX Category 048 messages which are conform to the EUROCONTROL standard.

However, as soon as an ASTERIX Category 007 message - a "Directed Interrogation" using the capabilities defined in this document - is received by the sensor, the sensor will acknowledge/reject the receipt and will process the directed interrogation. If acknowledged the Directed Interrogation is always performed one time (no continuous repetition, no continuous surveillance, "single shot" interrogation). As a result of such a Directed Interrogation the sensor will generate **additional category 007 reports** for those targets that were interrogated directly. In this case, a number of ASTERIX Category 048 and Category 007 messages related to the respective command will be issued and target messages which are subject of the directed interrogation processing of the sensor will – in addition to Category 048 - be sent in Category 007.

#### 1.2.2 ASTERIX Category

Messages used to implement the Direct Interrogation functionality are data out of Data Category 007.

#### 1.2.3 Implementation Issues

Compared to the original ASTERIX category 048 a number of items were added. These items are those with a number I007/400 and above.

Additionally the contents of the "Reserved Expansion Field" of category 048 was integrated into the normal structure of the category as item I007/085.

This page is intentionally left blank

## **2. REFERENCES**

### **2.1 General**

The following Documents and Standards contain provisions which, through references in this text, constitute provisions of this Eurocontrol Standard Document.

At the time of publication of this Eurocontrol Standard Document, the editions indicated for the referenced documents and standards were valid.

Any revision of the referenced ICAO Documents shall be immediately taken into account to revise this Eurocontrol Standard Document.

Revisions of the other referenced documents shall not form part of the provisions of this Eurocontrol Standard Document until they are formally reviewed and incorporated into this Eurocontrol Standard Document.

In the case of a conflict between the requirements of this Eurocontrol Standard Document and the contents of the other referenced documents, this Eurocontrol Standard Document shall take precedence.

### **2.2 Reference Documents**

1. Eurocontrol Standard 000-1-92. Directives for the Uniform Drafting and Presentation of Eurocontrol Standard Documents. 1992.
2. Eurocontrol Standard SUR.ET1.ST05.2000-STD-01-01. All Purpose Structured Eurocontrol Surveillance Information Exchange - ASTERIX. Edition 1.30, Released Issue, November 2007.
3. Eurocontrol Standard SUR.ET1.ST05.2000-04-01, "Eurocontrol Standard Document for Surveillance Data Exchange", Part 4 "Transmission of Monoradar Target Reports", Edition 1.20, June 2011.
4. Eurocontrol document "ASTERIX Part 4 Category 048 Appendix A Coding Rules for "Reserved Expansion Field"", Edition 1.4, June 2011.
5. STANAG 4193 Part V, § 3.2.5.

This page is intentionally left blank

### 3. DEFINITIONS, ACRONYMS AND ABBREVIATIONS

#### 3.1 Definitions

For the purposes of this Eurocontrol Standard Document, the following definitions shall apply:

- 3.1.1 Catalogue of Data Items:** List of all the possible Data Items of each Data Category describing the Data Items by their reference, structure, size and units (where applicable).
- 3.1.2 Data Block:** Unit of information seen by the application as a discrete entity by its contents. A Data Block contains one or more Record(s) containing data of the same category.
- 3.1.3 Data Category:** Classification of the data in order to permit inter alia an easy identification.
- 3.1.4 Data Field:** Physical implementation for the purpose of communication of a Data Item, it is associated with a unique Field Reference Number and is the smallest unit of transmitted information.
- 3.1.5 Data Item:** The smallest unit of information in each Data Category.
- 3.1.6 Measured Item:** A piece of information (e.g. the position of a target) directly derived from the radar information and transmitted without any intermediate processing.
- 3.1.7 Mode S:** An enhanced mode of SSR which permits the interrogation of all SSR equipped aircraft and the addressed interrogation of suitably equipped aircraft and two-way exchange of digital data between such aircraft and the interrogator.
- 3.1.8 Record:** A collection of transmitted Data Fields of the same category preceded by a Field Specification field, signalling the presence/absence of the various Data Fields
- 3.1.9 User Application Profile:** The mechanism for assigning Data Items to Data Fields, and containing all necessary information which needs to be standardised for the successful encoding and decoding of the messages.

### 3.2 Acronyms and Abbreviations

For the purposes of this Eurocontrol Standard Document the following shall apply:

<b>ACAS</b>	Airborne Collision Avoidance System
<b>ASTERIX</b>	All Purpose STructured Eurocontrol suRveillance Information EXchange
<b>BDS</b>	COMM B Data Selector
<b>CAT</b>	Data Category
<b>dBm</b>	The dBm is the unit of absolute power related to 1 milliwatt.
<b>Dg</b>	Degrees
<b>IFF</b>	Identification Friend/Foe
<b>EATMP</b>	European Air Traffic Control Management Programme
<b>ELM</b>	Extended Length Message
<b>FL</b>	Flight Level, unit of altitude (expressed in 100's of feet)
<b>FRN</b>	Field Reference Number
<b>FSPEC</b>	Field Specification
<b>FX</b>	Field Extension Indicator
<b>GICB</b>	Ground Initiated Comm-B
<b>ICAO</b>	International Civil Aviation Organization
<b>kt</b>	knot = NM/hour, unit of speed
<b>LEN</b>	Length Indicator
<b>LSB</b>	Least Significant Bit
<b>MB</b>	Message, Comm B
<b>MSB</b>	Most Significant Bit
<b>MSSR</b>	Monopulse Secondary Surveillance Radar
<b>MTD</b>	Moving Target Detection
<b>NM</b>	Nautical Mile, unit of distance (1852 metres)
<b>PSR</b>	Primary Surveillance Radar
<b>RA</b>	Resolution Advisory
<b>RDP</b>	Radar Data Processing
<b>REP</b>	Field Repetition Indicator
<b>REF</b>	Reserved Expansion Field
<b>RSSP</b>	Radar Systems Specialist Panel

<b>s</b>	second, unit of time
<b>SAC</b>	System Area Code
<b>SARPs</b>	Standards and Recommended Practices (ICAO)
<b>SDP</b>	Surveillance Data Processing (system)
<b>SIC</b>	System Identification Code
<b>SP</b>	Special Purpose Indicator
<b>SPI</b>	Special Position Identification
<b>SSR</b>	Secondary Surveillance Radar
<b>STFRDE</b>	Surveillance Task Force on Radar Data Exchange
<b>SURT</b>	Surveillance Team (EATMP)
<b>TCAS</b>	Traffic Alert and Collision-Avoidance System
<b>UAP</b>	User Application Profile (see Definitions )
<b>UTC</b>	Co-ordinated Universal Time
<b>W/E</b>	Warning/Error Condition

This page is intentionally left blank



## 4. GENERAL PRINCIPLES

### 4.1 General

The transmission of Directed Interrogations requires the transmission of three types of messages:

- Data messages for the initiation of Direct Interrogations and the target responses to these interrogations, both encoded in ASTERIX category 007. Rules and procedures specific to these messages are described in chapters 6 and 7 of this document.
- data messages of radar target reports following standard interrogations, encoded in ASTERIX category 048 (not covered by this document);
- radar service messages used to signal status information of the radar station to the user systems (not covered by this document).

### 4.2 Time Management

#### 4.2.1 Definition

The target time stamp shall be consistent with the reported plot position.

#### 4.2.2 Requirements for Time Stamping

The timestamping shall comply with the following requirements:

- every individual target report shall have its own individual timestamp;
- co-ordinated Universal Time (UTC) as specified in ICAO Annex 5 shall be used to time stamp radar data.

### 4.3 Projection Systems and Geographical Co-ordinates

#### 4.3.1 Measured Position

The *measured* position, as contained in plots or tracks, shall be provided by Data Item I007/040 as *slant polar co-ordinates*, with the radar site location serving as the origin of the polar co-ordinate system. The reference for the azimuth shall be **local geographical** north.

#### 4.3.2 Calculated Position

Two different types of co-ordinate reference systems are supported for local tracking purposes.

#### 4.3.2.1 Co-ordinates Expressed in the Radar Plane

When no stereographical projection is performed, the 3D to 2D co-ordinate transformation process is defined by the following simple equations:

$$X = RHO * SIN(THETA);$$

$$Y = RHO * COS(THETA);$$

Whereby:

RHO = measured slant range

THETA = measured azimuth

The reference for the azimuth shall be local geographical north.

#### 4.3.2.2 Co-ordinates Expressed in the Local 2D Co-ordinate Reference System:

The exported calculated position is expressed in a 2D Cartesian co-ordinate system, which is a plane tangential to the WGS-84 Ellipsoid at the location of the radar head. The origin of the Cartesian co-ordinate system coincides with the radar head position. The Y-axis points to the geographical north at that position. The X-axis is perpendicular to the Y-axis and points to the east. The X, Y co-ordinates are calculated using either the measured height or an assumed target height and apply a suitable projection technique for the final 3D to 2D conversion (e.g. a stereographical projection).

The type of co-ordinate reference system in use is signalled by a flag within the Track Status Data Item I007/170.

All tracker derived information elements, shall be a consistent set of values, expressed in the same co-ordinate reference system (state vector components and the corresponding elements of the track quality vector).

#### 4.4 Unused Bits in Data Items.

Decoders of ASTERIX data **shall never assume and rely on** specific settings of spare or unused bits. However in order to improve the readability of binary dumps of ASTERIX records, it is recommended to set all spare bits to zero.

#### 4.5 Definitions and Addressing Concepts

In order to address radar sources in an unambiguous way, a simple abstract model for concepts like sensors or radar systems has been designed.

##### 4.5.1 Radar Sensor

In the framework of category 007 a Radar Sensor is a detection/measurement device, either of the Primary (PSR), Secondary Surveillance Radar (SSR, MSSR) or Mode S type, which uses a single rotating antenna assembly.

##### 4.5.2 Radar System

In the framework of category 007 a Radar System is a construction, consisting of either **one single** sensor or a **combination of two** sensors of different types. In the case of combined sensors it is assumed that the respective antenna subsystems are configured, such that:

- a coincidence in target detection is guaranteed;
- a single co-ordinate reference point is used.

#### 4.5.3 Combination of Target Reports

The Radar Data Combiner is a function which combines (merges) the digitized target reports (plots) from two sensors constituting one Radar System.

#### 4.5.4 Addressing Concepts: Assigning SAC/SIC Codes

By convention a dedicated and unambiguous SAC/SIC code shall be assigned to every Radar System.

##### **EXAMPLES**

1. A back-to-back configuration of two PSRs with an on-mounted SSR antenna each, is considered as two Radar Systems, being addressed via two SAC/SIC codes.
2. A main tower carrying a combined PSR/SSR radar station, supplemented with a standby tower at several hundreds of meters from the main tower and supporting a single back-up SSR station, shall be considered as two independent Radar Systems. It is irrelevant whether both radar systems are synchronised or not, and in addition whether only one Radar System at a time transmits its data or both Radar Systems simultaneously.
3. Two distinct radar heads, located at close distance, whose data is processed in a time-exclusive way by the same plot processor equipment may be considered as a single Radar System, using a single SAC/SIC address, provided that:
  - the same geographical reference point is used, irrespective of whether the data of head#1 or head#2 is selected;
  - the access lines to the site carry only the data of one head at a time.

Where the above conditions are not simultaneously met, it is imperative to assign two SAC/SIC codes.

## 4.6 Radar Target Reports

### 4.6.1 Types of Radar Target Reports

Radar target reports shall be transmitted either in the form of plots or tracks. A track is a superset of a plot, containing additional data generated by a local tracking system at the radar site.

### 4.6.2 User Application Profile and Data Blocks

4.6.2.1 A single User Application Profile (UAP) is defined and shall be used whether plot or track information is provided by the radar.

4.6.2.2 Data Blocks containing radar target reports shall have the following layout.

<b>CAT = 007</b>	<b>LEN</b>	<b>FSPEC</b>	Items of the first record	<b>FSPEC</b>	Items of the last record
------------------	------------	--------------	---------------------------	--------------	--------------------------

where:

- Data Category (CAT) = 007, is a one-octet field indicating that the Data Block contains radar target reports;
- Length Indicator (LEN) is a two-octet field indicating the total length in octets of the Data Block, including the CAT and LEN fields;
- FSPEC is the Field Specification.

## 4.7 Composition of Messages

4.7.1 Messages shall be composed of Data Items assembled in the order defined by the Field Reference Number (FRN) in the associated UAP.

4.7.2 Transmitted items shall always be in a Record with the corresponding FSPEC bits set to one.

## 5. LAYOUT OF CATEGORY 007 MESSAGES

### 5.1 Standard Data Items

The standardised Data Items which shall be used for the transmission of category 007 messages in the scope of Directed Interrogations are defined in Table 1 and described in the following pages.

**Table 1 - Standard Data Items of Category 007**

Data Item Ref. No.	Description	System Units
I007/010	Data Source Identifier	N.A.
I007/020	Target Report Descriptor	N.A.
I007/025	Data Destination Identifier	N.A.
I007/030	Warning/Error Conditions	N.A.
I007/040	Measured Position in Slant Polar Co-ordinates	RHO: 1/256 NM THETA: 360°(2 <sup>16</sup> )
I007/042	Calculated Position in Cartesian Co-ordinates	X, Y: 1/128 NM
I007/050	Mode-2 Code in Octal Representation	N.A.
I007/055	Mode-1 Code in Octal Representation	N.A.
I007/060	Mode-2 Code Confidence Indicator	N.A.
I007/065	Mode 1 Code Confidence Indicator	N.A.
I007/070	Mode-3/A Code in Octal Representation	N.A.
I007/080	Mode-3/A Code Confidence Indicator	N.A.
I007/085	Mode 5, Extended Mode 1, X-Pulse	N.A.
I007/090	Flight Level in Binary Representation	1/4 FL
I007/100	Mode-C Code and Confidence Indicator	N.A.
I007/110	Height Measured by a 3D Radar	25 ft
I007/120	Radial Doppler Speed	(2 <sup>-14</sup> ) NM/s
I007/130	Radar Plot Characteristics	N.A.
I007/140	Time of Day	1/128 s
I007/161	Track/Plot Number	N.A.
I007/170	Track Status	N.A.
I007/200	Calculated Track Velocity in Polar Representation	Speed: (2 <sup>-14</sup> ) NM/s Heading: 360°(2 <sup>16</sup> )
I007/210	Track Quality	N.A.
I007/220	Aircraft Address	N.A.
I007/230	Communications / ACAS Capability and Flight Status	N.A.
I007/240	Aircraft Identification	N.A.
I007/250	Mode S MB Data	N.A.
I007/260	ACAS Resolution Advisory Report	N.A.
I007/400	Direct Interrogation Request Number	N.A.
I007/410	Direct Interrogation Message Type	N.A.
I007/415	Required Interrogation Modes	N.A.
I007/420	Direct Interrogation Window	N.A.
I007/440	Direct Interrogation BDS Register Request	N.A.
I007/450	Direct Interrogation Result	N.A.

## 5.2 Description of Standard Data Items

### 5.2.1 Data Item I007/010, Data Source Identifier

**Definition:** Identification of the radar station from which the data is received.

**Format:** Two-octet fixed length Data Item.

**Structure:**

Octet no. 1								Octet no. 2							
16	15	14	13	12	11	10	9	8	7	6	5	4	3	2	1
SAC								SIC							

bits-16/9 (SAC)                      System Area Code

bits-8/1 (SIC)                      System Identification Code

**Encoding Rule:**

This Item shall be present in every ASTERIX record.

**NOTE -** The up-to-date list of SACs is published on the Eurocontrol ASTERIX Web Site (<http://www.eurocontrol.int/asterix>).

### 5.2.2 Data Item I007/020, Target Report Descriptor

**Definition:** Type and properties of the target report.

**Format:** Variable length Data Item comprising a first part of one-octet, followed by one-octet extents as necessary.

**Structure  
of First Part:**

Octet no. 1							
8	7	6	5	4	3	2	1
TYP			SIM	RDP	SPI	RAB	FX

bits-8/6	(TYP)	= 000	No detection
		= 001	Single PSR detection
		= 010	Single SSR detection
		= 011	SSR + PSR detection
		= 100	Single ModeS All-Call
		= 101	Single ModeS Roll-Call
		= 110	ModeS All-Call + PSR
		= 111	ModeS Roll-Call +PSR
bit-5	(SIM)	= 0	Actual target report
		= 1	Simulated target report
bit-4	(RDP)	= 0	Report from RDP Chain 1
		= 1	Report from RDP Chain 2
bit-3	(SPI)	= 0	Absence of SPI
		= 1	Special Position Identification
bit-2	(RAB)	= 0	Report from aircraft transponder
		= 1	Report from field monitor (fixed transponder)
bit-1	(FX)	= 0	End of Data Item
		= 1	Extension into first extent

**NOTE -** For Mode S aircraft, the SPI information is also contained in I007/230.

**Structure  
of First Extent:**

Octet no. 1

8	7	6	5	4	3	2	1
TST	0	0	ME	MI	FOE/FRI		FX

bit-8	(TST)	= 0	Real target report
		= 1	Test target report
bits-7/6	(spare)		spare bits set to zero
bit-5	(ME)	= 0	No military emergency
		= 1	Military emergency
bit-4	(MI)	= 0	No military identification
		= 1	Military identification
bits-3/2	(FOE/FRI)	= 00	No Mode 4 interrogation
		= 01	Friendly target
		= 10	Unknown target
		= 11	No reply
bit-1	(FX)	= 0	End of Data Item
		= 1	Extension into next extent

**Encoding Rule:**

This Data Item shall be present in every target record.

**NOTE -** To bits 3/2 (FOE/FRI): IFF interrogators supporting a three level classification of the processing of the Mode 4 interrogation result shall encode the detailed response information in data item M4E of the Reserved Expansion Field of category 007. In this case the value for FOE/FRI in I007/020 shall be set to "00".



**5.2.3 Data Item I007/025, Data Destination Identifier**

**Definition:** Identification of the radar station to which the data is sent.

**Format:** Two-octet fixed length Data Item.

**Structure:**

Octet no. 1								Octet no. 2							
16	15	14	13	12	11	10	9	8	7	6	5	4	3	2	1
SAC								SIC							

bits-16/9 (SAC) System Area Code

bits-8/1 (SIC) System Identification Code

**Encoding Rule:**

This item shall be present in all ASTERIX records related to Direct Interrogations

**NOTE -** The up-to-date list of SACs is published on the Eurocontrol ASTERIX Web Site (<http://www.eurocontrol.int/asterix>).

**5.2.4 Data Item I007/030, Warning/Error Conditions**

**Definition:** Warning/error conditions detected by a radar station for the target report involved.

**Format:** Variable length Data Item comprising a first part of one-octet, followed by one-octet extents as necessary.

**Structure:**

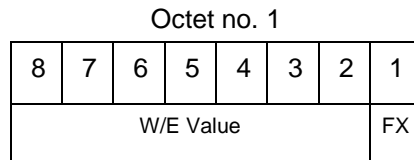

bits-8/2 (W/E Value) Warning/error condition value

bit-1 (FX) = 0 End of Data Item  
 = 1 Extension into first extent (next W/E condition value)

Warning/Error Code	Description
0	Not defined; never used.
1	Multipath Reply (Reflection)
2	Reply due to sidelobe interrogation/reception
3	Split plot
4	Second time around reply
5	Angel
6	Slow moving target correlated with road infrastructure (terrestrial vehicle)
7	Fixed PSR plot
8	Slow PSR target
9	Low quality PSR plot
10	Phantom SSR plot
11	Non-Matching Mode-3/A Code
12	Mode C code / Mode S altitude code abnormal value compared to the track
13	Target in Clutter Area
14	Maximum Doppler Response in Zero Filter
15	Transponder anomaly detected
16	Duplicated or Illegal Mode S Aircraft Address
17	Mode S error correction applied
18	Undecodable Mode C code / Mode S altitude code
19	Birds
20	Flock of Birds
21	Mode 1 was present in original reply
22	Mode 2 was present in original reply
23	Plot potentially caused by Wind Turbine
64	Ambiguous acknowledge, overlapping interrogation windows
65	Ambiguous acknowledge, duplicated request for same Mode S address
66	Ambiguous acknowledge, duplicated request for same track number
67	Reject, unable to process
68	Reject, too many parallel requests (exceeds system parameter for maximum number of requests per scan)
69	Reject, duplicated request

**Encoding Rule:**

This Data Item is optional. When used, it shall be transmitted only if different from zero. The zero value for this field means no warning neither error conditions.

**NOTES**

1. It has to be stressed that a series of one or more W/E conditions can be reported per message.
2. Data conveyed in this item for target reports are of secondary importance, and can generally also be derived from the processing of mandatory items.
3. Definitions can be found in SUR.ET1.ST03.1000-STD-01-01 Radar Sensor Performance Analysis.
4. Warning/Error codes of 64 and higher are reserved for Directed Interrogation messages.

**5.2.5**

**Data Item I007/040, Measured Position in Polar Co-ordinates**

**Definition:** Measured position of an aircraft in local polar co-ordinates.

**Format:** Four-octet fixed length Data Item.

**Structure:**

Octet no. 1										Octet no. 2					
32	31	30	29	28	27	26	25	24	23	22	21	20	19	18	17
RHO													LSB		

Octet no. 3										Octet no. 4					
16	15	14	13	12	11	10	9	8	7	6	5	4	3	2	1
THETA													LSB		

bit-17 (LSB) = 1/256 NM.  
Max. range = 256 NM

bit-1 (LSB) =  $360 \times 2^{16} = \text{approx. } 0.0055^\circ$

**Encoding Rule:**

For target reports, this item shall be sent when there is a detection.

**NOTES**

1. In case of no detection, the extrapolated position expressed in slant polar co-ordinates may be sent, except for a track cancellation message. No detection is signalled by the TYP field set to zero in I007/020 Target Report Descriptor.
2. This item represents the measured target position of the plot, even if associated with a track, for the present antenna scan. It is expressed in polar co-ordinates in the local reference system, centred on the radar station.
3. In case of combined detection by a PSR and an SSR, then the SSR position is sent.

**5.2.6 Data Item I007/042, Calculated Position in Cartesian Co-ordinates**

**Definition:** Calculated position of an aircraft in Cartesian co-ordinates.

**Format:** Four-octet fixed length Data Item .

**Structure:**

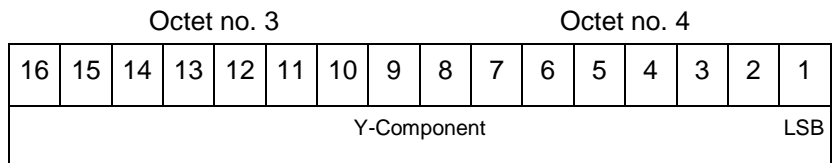
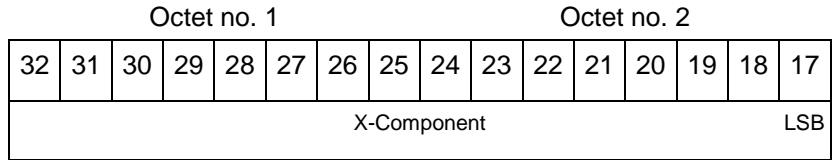

bit-17 (LSB) = 1/128 NM  
 Max. range = ±256 NM

bit-1 (LSB) = 1/128 NM  
 Max. range = ±256 NM

**Encoding Rule:**

This item is optional.

**5.2.7 Data Item I007/050, Mode-2 Code in Octal Representation**

**Definition :** Reply to Mode-2 interrogation.

**Format:** Two-octet fixed length Data Item.

**Structure:**

Octet no. 1								Octet no. 2							
16	15	14	13	12	11	10	9	8	7	6	5	4	3	2	1
V	G	L	0	A4	A2	A1	B4	B2	B1	C4	C2	C1	D4	D2	D1

- bit-16 (V) = 0 Code validated  
 = 1 Code not validated
- bit-15 (G) = 0 Default  
 = 1 Garbled code
- bit-14 (L) = 0 Mode-2 code as derived from the reply of the transponder  
 = 1 Smoothed Mode-2 code as provided by a local tracker
- bit-13 Spare bit set to 0
- bits-12/1 Mode-2 code in octal representation

**Encoding Rule:**

This item is optional. When used, it shall be sent when :

- Mode 2 is present. Then, it represents the Mode 2 code for the plot, even if associated with a track.
- Mode 2 is absent and local tracking is performed. It shall then be sent with the bit-14 (L) set to one.

**NOTE -** Bit 15 has no meaning in the case of a smoothed Mode-2 and is set to 0 for a calculated track.

**5.2.8 Data Item I007/055, Mode-1 Code in Octal Representation**

**Definition:** Reply to Mode-1 interrogation

**Format:** One octet fixed length data item.

**Structure:**

Octet no. 1							
8	7	6	5	4	3	2	1
V	G	L	A4	A2	A1	B2	B1

- bit-8 (V) = 0 Code validated  
 = 1 Code not validated
  
- bit-7 (G) = 0 Default  
 = 1 Garbled Code
  
- bit-6 (L) = 0 Mode-1 code as derived from the reply of the transponder.  
 = 1 Smoothed Mode-1 code as provided by a local tracker.
  
- bits-5/1 Mode-1 code

**Encoding Rule:**

This item is optional. When used, it shall be sent when:

- Mode 1 is present. Then, it represents the Mode 1 code for the plot, even if associated with a track.
- Mode 1 is absent and local tracking is performed. It shall then be sent with the bit-6 (L) set to one.

**NOTE -** Bit 7 has no meaning in the case of a smoothed Mode 1 and is set to 0 for a calculated track.

**5.2.9 Data Item I007/060, Mode-2 Code Confidence Indicator**

**Definition:** Confidence level for each bit of a Mode-2 reply as provided by a monopulse SSR station.

**Format:** Two-octet fixed length Data Item.

**Structure:**

Octet no. 1								Octet no. 2							
16	15	14	13	12	11	10	9	8	7	6	5	4	3	2	1
0	0	0	0	QA4	QA2	QA1	QB4	QB2	QB1	QC4	QC2	QC1	QD4	QD2	QD1

bits-16/13

Spare bits set to 0

bits-12/1 (QXi) = 0 High quality pulse Xi  
 = 1 Low quality pulse Xi

**Encoding Rule:**

This data item is optional.

When used, it shall be transmitted only when at least one pulse is of low quality. It represents the confidence level for each reply bit of the Mode 2 code of the plot.

**5.2.10 Data Item I007/065, Mode-1 Code Confidence Indicator**

**Definition:** Confidence level for each bit of a Mode-1 reply as provided by a monopulse SSR station.

**Format:** One-octet fixed length Data Item.

**Structure:**

Octet no. 1							
8	7	6	5	4	3	2	1
0	0	0	QA4	QA2	QA1	QB2	QB1

bits-8/6

Spare bits set to zero

bits-5/1 (QXi) = 0 High quality pulse Xi  
 = 1 Low quality pulse Xi

**Encoding Rule:**

This data item is optional.

When used, it shall be transmitted only when at least one pulse is of low quality. It represents the confidence level for each reply bit of the Mode 1 code of the plot.

**5.2.11 Data Item I007/070, Mode-3/A Code in Octal Representation**

**Definition:** Mode-3/A code converted into octal representation.

**Format:** Two-octet fixed length Data Item.

**Structure:**

Octet no. 1								Octet no. 2							
16	15	14	13	12	11	10	9	8	7	6	5	4	3	2	1
V	G	L	0	A4	A2	A1	B4	B2	B1	C4	C2	C1	D4	D2	D1

bit-16	(V)	= 0	Code validated
		= 1	Code not validated
bit-15	(G)	= 0	Default
		= 1	Garbled code
bit-14	(L)	= 0	Mode-3/A code derived from the reply of the transponder
		= 1	Mode-3/A code not extracted during the last scan
bit-13			Spare bit set to 0
bits-12/1			Mode-3/A reply in octal representation

**Encoding Rule:**

- When Mode-3/A code is present, this item shall be sent. Then, it represents the Mode-3/A code for the plot, even if associated with a track.
- When Mode-3/A code is absent and local tracking is performed, it shall be sent with the bit-14 (L) set to one.
- For Mode S, once a Mode-3/A code is seen, that code shall be sent every scan, provided the radar is receiving replies for that aircraft.

**NOTES**

1. Bit 15 has no meaning in the case of a smoothed Mode-3/A code and is set to 0 for a calculated track. For Mode S, it is set to one when an error correction has been attempted.
2. For Mode S, bit 16 is normally set to zero, but can exceptionally be set to one to indicate a non-validated Mode-3/A code (e.g. alert condition detected, but new Mode-3/A code not successfully extracted).



**5.2.12 Data Item I007/080, Mode-3/A Code Confidence Indicator**

**Definition:** Confidence level for each bit of a Mode-3/A reply as provided by a monopulse SSR station.

**Format:** Two-octet fixed length Data Item.

**Structure:**

Octet no. 1								Octet no. 2							
16	15	14	13	12	11	10	9	8	7	6	5	4	3	2	1
0	0	0	0	QA4	QA2	QA1	QB4	QB2	QB1	QC4	QC2	QC1	QD4	QD2	QD1

bits-16/13

Spare bits set to 0

bits-12/1 (QXi) = 0 High quality pulse Xi  
 = 1 Low quality pulse Xi

**Encoding Rule:**

This data item is optional.

When used, it shall be transmitted only when at least one pulse is of low quality. It represents the confidence level for each reply bit of the Mode-3/A code of the plot.

### 5.2.13 Data Item I007/085, Mode 5, Extended Mode 1 and X-Pulse

**Definition:** Information from Mode 5 interrogations, extended Mode 1 or X-Pulse Presence.

**Format:** Compound Data Item, comprising a primary subfield of one octet, followed by one of the defined subfields.

**Note:** In 2011 NATO has modified the format of the National Origin information available in subfield 2 of the Mode 5 data item. The information for National Origin and Mission Code were combined into a 11-bit long field. In order to maintain backwards compatibility and to ease the use of the new layout, this original Mode 5 data item (I007/085) was copied into the Reserved Expansion Field as data item "M5N Mode 5 New" and the layout of subfield #2 adapted.

The new layout as reflected in the data item M5N of the Reserved Expansion Field shall be used by equipment prepared for the new National Origin system.

Equipment certified to the previous encoding shall continue to use this data item I007/085 corresponding to the 5-bit National Origin / 6-bit Mission Code.

**Structure of Primary Subfield:**

Octet no. 1							
8	7	6	5	4	3	2	1
SUM	PMN	POS	GA	EM1	TOS	XP	FX

- bit-8, octet 1 (SUM) Subfield #1: Mode 5 Summary  
 =0 Absence of Subfield #1  
 =1 Presence of Subfield #1
- bit-7, octet 1 (PMN) Subfield #2: Mode 5 PIN/ National Origin/Mission Code  
 =0 Absence of Subfield #2  
 =1 Presence of Subfield #2
- bit-6, octet 1 (POS) Subfield #3: Mode 5 Reported Position  
 =0 Absence of Subfield #3  
 =1 Presence of Subfield #3
- bit-5, octet 1 (GA) Subfield #4: Mode 5 GNSS-derived Altitude  
 =0 Absence of Subfield #4  
 =1 Presence of Subfield #4
- bit-4, octet 1 (EM1) Subfield #5: Extended Mode 1 Code in Octal Representation  
 =0 Absence of Subfield #5  
 =1 Presence of Subfield #5
- bit-3, octet 1 (TOS) Subfield #6: Time Offset for POS and GA.  
 =0 Absence of Subfield #6  
 =1 Presence of Subfield #6
- bit-2, octet 1 (XP) Subfield #7: X Pulse Presence  
 =0 Absence of Subfield #7  
 =1 Presence of Subfield #7
- bit-1, octet 1 (FX) = 0 End of Primary Subfield  
 = 1 Extension of Primary Subfield into next octet

**Structure of Subfield #1:  
Mode 5 Summary:**

Octet no. 1							
8	7	6	5	4	3	2	1
M5	ID	DA	M1	M2	M3	MC	0

bit-8	(M5)	= 0 No Mode 5 interrogation = 1 Mode 5 interrogation
bit-7	(ID)	= 0 No authenticated Mode 5 ID reply = 1 Authenticated Mode 5 ID reply
bit-6	(DA)	= 0 No authenticated Mode 5 Data reply or Report = 1 Authenticated Mode 5 Data reply or Report (i.e any valid Mode 5 reply type other than ID)
bit-5	(M1)	= 0 Mode 1 code not present or not from Mode 5 reply = 1 Mode 1 code from Mode 5 reply.
bit-4	(M2)	= 0 Mode 2 code not present or not from Mode 5 reply = 1 Mode 2 code from Mode 5 reply.
bit-3	(M3)	= 0 Mode 3 code not present or not from Mode 5 reply = 1 Mode 3 code from Mode 5 reply.
bit-2	(MC)	= 0 Mode C altitude not present or not from Mode 5 reply = 1 Mode C altitude from Mode 5 reply
bit-1	Spare bit set to 0	

**Notes:**

1. The flags M2, M3, MC refer to the contents of data items I048/050, I048/070 and I048/090 respectively. The flag M1 refers to the contents of data item I048/055, Mode 1 Code in Octal Representation, and to the contents of the Subfield #5 (Extended Mode 1 Code in Octal Representation).
2. If an authenticated Mode 5 reply is received with the Emergency bit set, then the Military Emergency bit (ME) in Data Item I048/020, Target Report Descriptor, shall be set.
3. If an authenticated Mode 5 reply is received with the Identification of Position bit set, then the Special Position Identification bit (SPI) in Data Item I048/020, Target Report Descriptor, shall be set.

**Structure of Subfield #2:  
Mode 5 PIN /National Origin/ Mission Code**

Octet no. 1								Octet no. 2							
32	31	30	29	28	27	26	25	24	23	22	21	20	19	18	17
0	0	PIN												(LSB)	

Octet no. 3								Octet no. 4								
16	15	14	13	12	11	10	9	8	7	6	5	4	3	2	1	
0	0	0	NAT				(LSB)	0	0	MIS						(LSB)

- bits-32/31 (spare)                      spare bits set to 0
- bits-30/17 (PIN)                      PIN Code
- bits-16/14 (spare)                      spare bits set to 0
- bits-13/9 (NAT)                      National Origin
- bits-8/7 (spare)                      spare bits set to 0
- bits-6/1 (MIS)                      Mission Code

**Structure of Subfield #3:  
Mode 5 Reported Position**

Octet no. 1								Octet no. 2							
48	47	46	45	44	43	42	41	40	39	38	37	36	35	34	33
Latitude in WGS 84															

Octet no. 3								Octet no. 4							
32	31	30	29	28	27	26	25	24	23	22	21	20	19	18	17
(LSB)								Longitude in WGS 84							

Octet no. 5								Octet no. 6							
16	15	14	13	12	11	10	9	8	7	6	5	4	3	2	1
(LSB)															

bits-48/25 (LAT)                      Latitude in WGS 84

bits-24/1 (LON)                      Longitude in WGS 84

**Notes :** Latitude in WGS 84 is expressed as a 24-bit two's complement number.  
Range  $-90^{\circ} \leq \text{latitude} \leq 90^{\circ}$ . Sign convention: North is positive.  
LSB =  $180/2^{23}$  degrees =  $2.145767 \cdot 10^{-05}$  degrees

Longitude in WGS 84 is expressed as a 24-bit two's complement number.  
Range  $-180^{\circ} \leq \text{longitude} < 180^{\circ}$ . Sign convention: East is positive.  
LSB =  $180/2^{23}$  degrees =  $2.145767 \cdot 10^{-05}$  degrees

The resolution implied by the LSB is better than the resolution with which Mode 5 position reports are transmitted from aircraft transponders using currently defined formats.

**Structure of Subfield #4:  
Mode 5 GNSS-derived Altitude**

Octet no. 1							Octet no. 2								
16	15	14	13	12	11	10	9	8	7	6	5	4	3	2	1
0	RES	GA											(LSB)		

bit-16 (spare) spare bit set to 0

bit-15 (RES) Resolution with which the GNSS-derived Altitude (GA) is reported.  
=0 GA reported in 100 ft increments,  
=1 GA reported in 25 ft increments.

bits-14/1 (GA) GNSS-derived Altitude of target, expressed as height above WGS 84 ellipsoid. GA is coded as a 14-bit two's complement binary number with an LSB of 25 ft. irrespective of the setting of RES. The minimum value of GA that can be reported is -1000 ft.

**Structure of Subfield #5:  
Extended Mode 1 Code in Octal Representation**

Octet 1							Octet 2								
16	15	14	13	12	11	10	9	8	7	6	5	4	3	2	1
0	0	0	0	Extended Mode 1 Code											
				A4	A2	A1	B4	B2	B1	C4	C2	C1	D4	D2	D1

bit 16/13 Spare bits set to 0

bits-12/1 (EM1) Extended Mode 1 Code in octal representation

**Note:** If Subfield #1 is present, the M1 bit in Subfield #1 indicates whether the Extended Mode 1 Code is from a Mode 5 reply or a Mode 1 reply. If Subfield #1 is not present, the Extended Mode 1 Code is from a Mode 1 reply.

**Structure of Subfield #6:  
Time Offset for POS and GA**

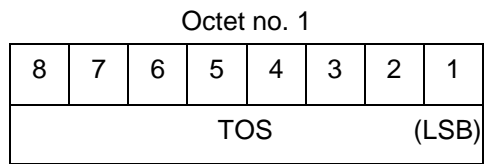

bits-8/1 (TOS)

Time Offset coded as a twos complement number with an LSB of 1/128 s. The time at which the Mode 5 Reported Position (Subfield #3) and Mode 5 GNSS-derived Altitude (Subfield #4) are valid is given by Time of Day (I048/140) plus Time Offset.

**Note:**

TOS shall be assumed to be zero if Subfield #6 is not present.



**Structure of Subfield #7:  
X Pulse Presence**

Octet no. 1							
8	7	6	5	4	3	2	1
0	0	0	X5	XC	X3	X2	X1

bits-8/6 spare bits set to zero

bit-5	(X5)	X-pulse from Mode 5 Data reply or Report. = 0 X-pulse set to zero or no authenticated Data reply or Report received. = 1 X-pulse set to one (present).
bit-4	(XC)	X-pulse from Mode C reply = 0 X-pulse set to zero or no Mode C reply = 1 X-pulse set to one (present)
bit-3	(X3)	X-pulse from Mode 3/A reply = 0 X-pulse set to zero or no Mode 3/A reply = 1 X-pulse set to one (present)
bit-2	(X2)	X-pulse from Mode 2 reply = 0 X-pulse set to zero or no Mode 2 reply = 1 X-pulse set to one (present)
bit-1	(X1)	X-pulse from Mode 1 reply = 0 X-pulse set to zero or no Mode 1 reply = 1 X-pulse set to one (present)

**Encoding Rule:**

This item is optional.

When used to transmit MD5, it shall be sent when at least one of the following conditions is satisfied:

1. The target represented by the Monoradar Target Report has been interrogated in Mode 5.
2. A non-zero Extended Mode 1 Code is received.
3. An X-pulse is present.

If condition 1 is satisfied, then Subfield #1 (Mode 5 Summary) shall be present.

If condition 2 is satisfied then Subfield #5 (Extended Mode 1 Code in Octal Representation) shall be present.

If condition 3 is satisfied, then Subfield #7 (X Pulse Presence) shall be present.

**5.2.14 Data Item I007/090, Flight Level in Binary Representation**

**Definition:** Flight Level converted into binary representation.

**Format:** Two-octet fixed length Data Item.

**Structure:**

Octet no. 1								Octet no. 2							
16	15	14	13	12	11	10	9	8	7	6	5	4	3	2	1
V	G	Flight Level											LSB		

bit-16 (V) = 0 Code validated  
 = 1 Code not validated

bit-15 (G) = 0 Default  
 = 1 Garbled code

bits-14/1 (Flight Level) LSB= 1/4 FL

**Encoding Rule:**

This data item shall be sent when Mode C code or Mode S altitude code is present and decodable. It represents the flight level of the plot, even if associated with a track.

**NOTES**

1. When Mode C code / Mode S altitude code is present but not decodable, the "Undecodable Mode C code / Mode S altitude code" Warning/Error should be sent in I007/030.
2. When local tracking is applied and the received Mode C code / Mode S altitude code corresponds to an abnormal value (the variation with the previous plot is estimated too important by the tracker), the "Mode C code / Mode S altitude code abnormal value compared to the track" Warning/Error should be sent in I007/030.
3. The value shall be within the range described by ICAO Annex 10
4. For Mode S, bit 15 (G) is set to one when an error correction has been attempted.

**5.2.15 Data Item I007/100, Mode-C Code and Code Confidence Indicator**

**Definition:** Mode-C height in Gray notation as received from the transponder together with the confidence level for each reply bit as provided by a MSSR/Mode S station.

**Format:** Four-octet fixed length Data Item.

**Structure:**

Octet no. 1								Octet no. 2							
32	31	30	29	28	27	26	25	24	23	22	21	20	19	18	17
V	G	0	0	C1	A1	C2	A2	C4	A4	B1	D1	B2	D2	B4	D4

Octet no. 3								Octet no. 4							
16	15	14	13	12	11	10	9	8	7	6	5	4	3	2	1
0	0	0	0	QC1	QA1	QC2	QA2	QC4	QA4	QB1	QD1	QB2	QD2	QB4	QD4

bit-32 (V) = 0 Code validated  
= 1 Code not validated

bit-31 (G) = 0 Default  
= 1 Garbled code

bits-30/29 Spare bits set to 0

bits-28/17 Mode-C reply in Gray notation

bits-16/13 Spare bits set to 0

bits-12/1 (QXi) = 0 High quality pulse Xi  
= 1 Low quality pulse Xi

**Encoding Rule:**

This data item is optional.

When used, it shall only be sent when a not validated or undecodable Mode C code has been received. For Mode A/C, it represents the confidence level for each reply bit of the Mode C code of the plot. For Mode S, if this item is sent because of an undecodable Mode-C code received in a Mode S altitude reply, all pulse quality bits will be set to high (zero).

**NOTES**

1. For Mode S, D1 is also designated as Q, and is used to denote either 25ft or 100ft reporting.
2. For Mode S, bit-31 (G) is set when an error correction has been attempted.

**5.2.16 Data Item I007/110, Height Measured by a 3D Radar**

**Definition:** Height of a target as measured by a 3D radar. The height shall use mean sea level as the zero reference level.

**Format:** Two-octet fixed length Data Item.

**Structure:**

Octet no.1								Octet no.2							
16	15	14	13	12	11	10	9	8	7	6	5	4	3	2	1
0	0	3D-Height												LSB	

bits-16/15

Spare bits set to zero

bits-14/1 (3D-Height)

3D height, in binary notation. Negative values are expressed in two's complement

LSB = 25 ft

**Encoding Rule:**

This data item is optional.

**5.2.17 Data Item I007/120, Radial Doppler Speed**

**Definition:** Information on the Doppler Speed of the target report.

**Format:** Compound Data Item, comprising a primary subfield of one octet, followed by one of the two defined subfields.

**Structure of**

**Primary Subfield:**

Octet no.1							
8	7	6	5	4	3	2	1
CAL	RDS	0	0	0	0	0	0

bit-8	(CAL)	Subfield #1: Calculated Doppler Speed = 0 Absence of Subfield #1 = 1 Presence of Subfield #1
bit-7	(RDS)	Subfield #2: Raw Doppler Speed = 0 Absence of Subfield #2 = 1 Presence of Subfield #2
bits-6/1	(Spare)	Subfields #3/7: Spare = 0 Absence of Subfield = 1 Presence of Subfield

**Structure of Subfield # 1:  
Calculated Doppler Speed**

Octet no.1							Octet no. 2									
16	15	14	13	12	11	10	9	8	7	6	5	4	3	2	1	
D	0					CAL										LSB

bit-16	(D)	= 0 Doppler speed is valid = 1 Doppler speed is doubtful
bits-15/11	(Spare)	Fixed to zero
bits-10/1	(CAL)	Calculated Doppler Speed, coded in two's complement LSB= 1 m/sec

**Structure of Subfield # 2:  
 Raw Doppler Speed**

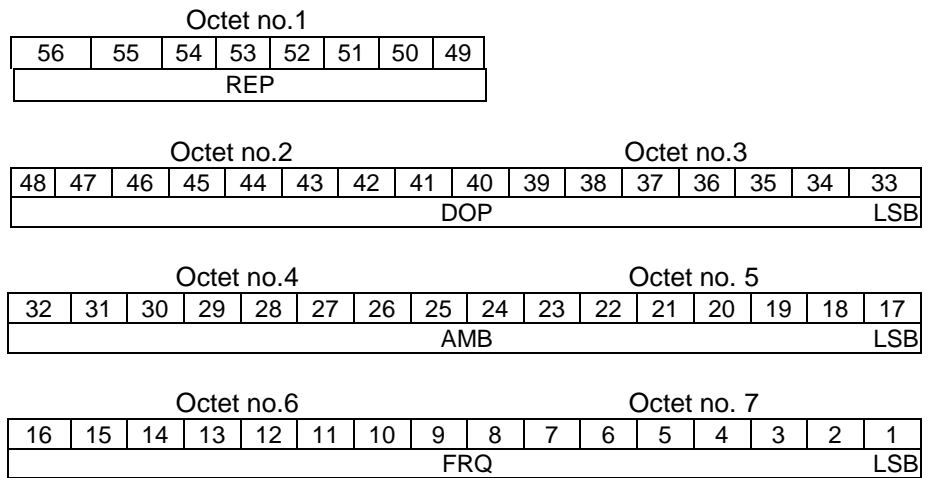

bits-56/49	(REP)	Repetition Factor
bit-48/33	(DOP)	Doppler Speed
		LSB= 1 m/sec
bits-32/17	(AMB)	Ambiguity Range
		LSB= 1 m/sec
bits-16/1	(FRQ)	Transmitter Frequency
		LSB= 1 Mhz

**Encoding Rule:**

This data item is optional. When used, only one secondary subfield shall be present.

**5.2.18 Data Item I007/130, Radar Plot Characteristics**

**Definition:** Additional information on the quality of the target report.

**Format:** Compound Data Item.

**Structure of Primary Subfield:**

Octet no.1							
8	7	6	5	4	3	2	1
SRL	SRR	SAM	PRL	PAM	RPD	APD	FX

bit-8, octet1	(SRL)	Subfield #1: SSR plot runlength = 0 Absence of Subfield #1 = 1 Presence of Subfield #1
bit-7, octet1	(SRR)	Subfield #2: Number of received replies for M(SSR) = 0 Absence of Subfield #2 = 1 Presence of Subfield #2
bit-6, octet1	(SAM)	Subfield #3: Amplitude of received replies for M(SSR) = 0 Absence of Subfield #3 = 1 Presence of Subfield #3
bit-5, octet1	(PRL)	Subfield #4: PSR plot runlength = 0 Absence of Subfield #4 = 1 Presence of Subfield #4
bit-4, octet1	(PAM)	Subfield #5: PSR amplitude = 0 Absence of Subfield #5 = 1 Presence of Subfield #5
bit-3, octet1	(RPD)	Subfield #6: Difference in Range between PSR and SSR plot = 0 Absence of Subfield #6 = 1 Presence of Subfield #6
bit-2, octet1	(APD)	Subfield #7: Difference in Azimuth between PSR and SSR plot = 0 Absence of Subfield #7 = 1 Presence of Subfield #7
bit-1, octet1	(FX)	= 0 End of Primary Subfield = 1 Extension of Primary Subfield into next octet



**Structure of Subfield # 1:  
SSR Plot Runlength**

Octet no.1							
8	7	6	5	4	3	2	1
SRL						LSB	

bits-8/1 (SRL)

SSR plot runlength, expressed as a positive binary value.  
LSB=360/2<sup>13</sup> dg (0.044 dg)

**NOTE -** The total range covered is therefore from 0 to 11.21 dg.

**Structure of Subfield # 2:  
Number of Received Replies for (M)SSR**

Octet no.1							
8	7	6	5	4	3	2	1
SRR						LSB	

bits-8/1 (SRR)

Number of received replies for (M)SSR  
LSB= 1

**Structure of Subfield # 3:  
Amplitude of (M)SSR Reply**

Octet no.1							
8	7	6	5	4	3	2	1
SAM						LSB	

bits-8/1 (SAM)

Amplitude of (M)SSR reply  
LSB= 1 dBm

**NOTE -** Negative values are coded in two's complement form.

**Structure of Subfield # 4:  
Primary Plot Runlength**

Octet no.1							
8	7	6	5	4	3	2	1
PRL						LSB	

bits-8/1 (PRL)

Primary Plot Runlength, expressed as positive binary value  
LSB= 360/2<sup>13</sup> dg (0.044 dg)

**NOTE -** The total range covered is therefore from 0 to 11.21 dg.

**Structure of Subfield # 5:  
Amplitude of Primary Plot**

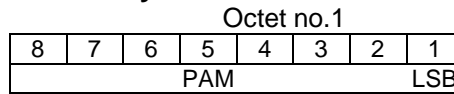

bits-8/1 (PAM) Amplitude of Primary Plot  
LSB= 1 dBm

**NOTE -** Negative values are coded in two's complement form.

**Structure of Subfield # 6:  
Difference in Range between PSR and SSR plot**

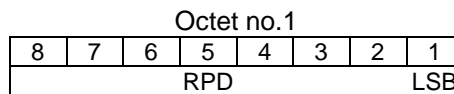

bits-8/1 (RPD) Range (PSR-SSR)  
LSB= 1/256 NM

**NOTES**

1. Negative values are coded in two's complement form.
2. The covered range difference is +/- 0.5 NM.
3. Sending the maximum value means that the difference in range is equal or greater than the maximum value.

**Structure of Subfield # 7:  
Difference in Azimuth between PSR and SSR plot**

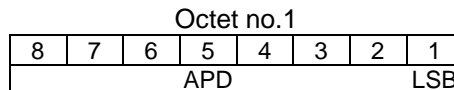

bits-8/1 (APD) Azimuth (PSR-SSR)  
LSB=  $360/2^{14}$  dg

**NOTES**

1. Negative values are coded in two's complement form.
2. The covered azimuth difference is  $\pm 360/2^7 = \pm 2.8125$  dg.
3. Sending the maximum value means that the difference in range is equal or greater than the maximum value.

**Encoding Rule:**

This data item is optional.  
When used, all secondary subfields are optional.

**Recommendation:** *For a combined target report, subfields RPD and APD of primary subfield should be present.*

**5.2.19 Data Item I007/140, Time of Day**

**Definition:** Absolute time stamping expressed as Co-ordinated Universal Time (UTC).

**Format:** Three-octet fixed length Data Item.

**Structure:**

Octet no. 1								Octet no. 2							
24	23	22	21	20	19	18	17	16	15	14	13	12	11	10	9
Time-of-Day															

Octet no. 3							
8	7	6	5	4	3	2	1
LSB							

bits-24/1 (Time-of-Day)

bit-1 (LSB)

Acceptable Range of values:  
 $0 \leq \text{Time-of-Day} \leq 24 \text{ hrs}$   
 $= 2^{-7} \text{ seconds} = 1/128 \text{ seconds}$

**Encoding Rule:**

This data item shall be present in every ASTERIX record, except in case of failure of all sources of time-stamping..

The time information, coded in three octets, shall reflect the exact time of an event, expressed as a number of 1/128 s elapsed since last midnight.

**NOTES**

1. The time of day value is reset to 0 each day at midnight.
2. Every radar station using ASTERIX should be equipped with at least one synchronised time source

**5.2.20 Data Item I007/161, Track Number**

**Definition:** An integer value representing a unique reference to a track record within a particular track file.

**Format:** Two-octet fixed length Data Item.

**Structure:**

Octet no. 1								Octet no. 2							
16	15	14	13	12	11	10	9	8	7	6	5	4	3	2	1
0	0	0	0	TRACK NUMBER (0..4095)											

**Encoding Rule:**

This data item shall be sent in target report messages when the radar station outputs tracks.

**5.2.21 Data Item I007/170, Track Status**

**Definition:** Status of monoradar track (PSR and/or SSR updated).

**Format:** Variable length Data Item comprising a first part of one-octet, followed by one-octet extents as necessary.

**Structure of First Part:**

Octet no.1							
8	7	6	5	4	3	2	1
CNF	RAD		DOU	MAH	CDM		FX

- bit-8 (CNF) Confirmed vs. Tentative Track
  - = 0 Confirmed Track
  - = 1 Tentative Track
- bits-7/6 (RAD) Type of Sensor(s) maintaining Track
  - = 00 Combined Track
  - = 01 PSR Track
  - = 10 SSR/Mode S Track
  - = 11 Invalid
- bit-5 (DOU) Signals level of confidence in plot to track association process
  - = 0 Normal confidence
  - = 1 Low confidence in plot to track association.
- bit-4 (MAH) Manoeuvre detection in Horizontal Sense
  - = 0 No horizontal man.sensed
  - = 1 Horizontal man. sensed
- bits-3/2 (CDM) Climbing / Descending Mode
  - = 00 Maintaining
  - = 01 Climbing
  - = 10 Descending
  - = 11 Invalid
- bit-1 (FX) End of Data Item
  - = 0 End of Data Item
  - = 1 Extension into first extent

**NOTE -** RAD can change after a number of non-matching with TYP in item 020.

**Structure  
of First Extent:**

Octet no.2							
8	7	6	5	4	3	2	1
TRE	GHO	SUP	TCC	0	0	0	FX

bit-8	(TRE)	= 0	Signal for End_of_Track Track still alive
		= 1	End of track lifetime(last report for this track)
bit-7	(GHO)	= 0	Ghost vs. true target True target track.
		= 1	Ghost target track.
bit-6	(SUP)	= 0	Track maintained with track information from neighbouring Node B on the cluster, or network
		= 1	no
bit-5	(TCC)	= 1	yes
		= 0	Type of plot coordinate transformation mechanism: Tracking performed in so- called 'Radar Plane', i.e. neither slant range correction nor stereographical projection was applied.
		= 1	Slant range correction and a suitable projection technique are used to track in a 2D.reference plane, tangential to the earth model at the Radar Site co-ordinates.
bits-4/2	(spare)		Spare bits
bit-1	(FX)	= 0	End of Data Item
		= 1	Extension into second extent

**Encoding Rule:**

This data item shall be sent when the radar station outputs tracks.

**5.2.22 Data Item I007/200, Calculated Track Velocity in Polar Co-ordinates**

**Definition:** Calculated track velocity expressed in polar co-ordinates.

**Format:** Four-octet fixed length Data Item.

**Structure:**

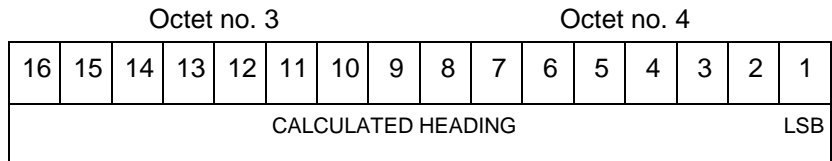
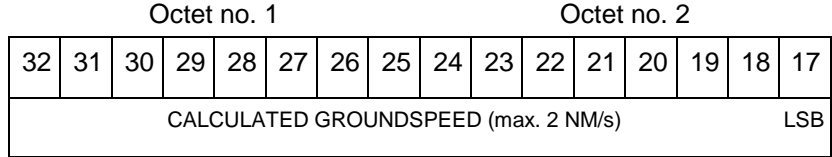

bit-17 (LSB) =  $(2^{-14})$  NM/s = approx. 0.22 kt

bit-1 (LSB) =  $360 \div 2^{16}$  = approx. 0.0055°

**Encoding Rule:**

This data item shall be sent in target report messages when the radar station outputs tracks, except for a track cancellation message.

**NOTE -** The calculated heading is related to the geographical North at the aircraft position.

5.2.23 Data Item I007/210, Track Quality

**Definition:** Track quality in the form of a vector of standard deviations.

**Format:** Four-octet fixed length Data Item.

**Structure:**

Octet no.1							
8	7	6	5	4	3	2	1
Sigma (X)							LSB

bits-8/1 (Sigma (X))

Standard Deviation on the horizontal axis of the local grid system

bit-1 (LSB)

= 1/128 NM

**NOTE -** The standard deviation is per definition a positive value, hence the range covered is :  $0 \leq \text{Sigma}(X) < 2 \text{ NM}$

Octet no.2							
8	7	6	5	4	3	2	1
Sigma (Y)							LSB

bits-8/1 (Sigma (Y))

Standard Deviation on the vertical axis of the local grid system

bit-1 (LSB)

= 1/128 NM

**NOTE -** The standard deviation is per definition a positive value, hence the range covered is:  $0 \leq \text{Sigma} (Y) < 2 \text{ NM}$

Octet no.3							
8	7	6	5	4	3	2	1
Sigma (V)							LSB

bits-8/1 (Sigma (V))

Standard Deviation on the groundspeed within the local grid system

bit-1 (LSB)

=  $(2^{-14}) \text{ NM/s} = 0.22 \text{ Kt}$

**NOTE -** The standard deviation is per definition a positive value, hence the range covered is:  $0 \leq \text{Sigma} (V) < 56.25 \text{ Kt}$

Octet no.4							
8	7	6	5	4	3	2	1
Sigma (H)							LSB

bits-8/1 (Sigma (H))

Standard Deviation on the heading within the local grid system

bit-1 (LSB)

=  $360 / (2^{12}) \text{ degrees} = 0.08789 \text{ degrees}$

**NOTE -** The standard deviation is per definition a positive value; hence the range covered is:  $0 \leq \text{sigma}(H) < 22.5 \text{ degrees}$ .

**Encoding Rule:**

This item is optional.

**5.2.24 Data Item I007/220, Aircraft Address**

**Definition:** Aircraft address (24-bits Mode S address) assigned uniquely to each aircraft.

**Format:** Three-octet fixed length Data Item.

**Structure:**

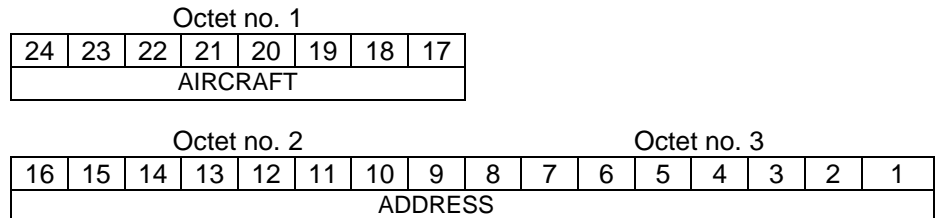

bits-24/1

24-bits Mode S address, A23 to A0

**Encoding Rule:**

This item shall be present in every ASTERIX record conveying data related to a Mode S target.



**5.2.25 Data Item I007/230, Communications/ACAS Capability and Flight Status**

**Definition:** Communications capability of the transponder, capability of the on-board ACAS equipment and flight status.

**Format:** Two-octet fixed length Data Item.

**Structure:**

Octet no. 1							Octet no. 2								
16	15	14	13	12	11	10	9	8	7	6	5	4	3	2	1
COM			STAT			SI	0	MSSC	ARC	AIC	B1A	B1B			

bits-16/14	(COM)	Communications capability of the transponder = 0 No communications capability (surveillance only) = 1 Comm. A and Comm. B capability = 2 Comm. A, Comm. B and Uplink ELM = 3 Comm. A, Comm. B, Uplink ELM and Downlink ELM = 4 Level 5 Transponder capability 5 to 7 Not assigned
bits-13/11	(STAT)	Flight Status = 0 No alert, no SPI, aircraft airborne = 1 No alert, no SPI, aircraft on ground = 2 Alert, no SPI, aircraft airborne = 3 Alert, no SPI, aircraft on ground = 4 Alert, SPI, aircraft airborne or on ground = 5 No alert, SPI, aircraft airborne or on ground 6 - 7 Not assigned
bit-10	(SI)	SI/II Transponder Capability = 0 SI-Code Capable = 1 II-Code Capable
bit-9	(spare)	spare bit set to zero
bit-8	(MSSC)	Mode-S Specific Service Capability = 0 No = 1 Yes
bit-7	(ARC)	Altitude reporting capability = 0 100 ft resolution = 1 25 ft resolution
bit-6	(AIC)	Aircraft identification capability = 0 No = 1 Yes
bit-5	(B1A)	BDS 1,0 bit 16
bits 4/1	(B1B)	BDS 1,0 bits 37/40

**Encoding Rule:**

This item shall be present in every ASTERIX record conveying data related to a Mode S target. If the datalink capability has not been extracted yet, bits 16/14 shall be set to zero.

**5.2.26 Data Item I007/240, Aircraft Identification**

**Definition:** Aircraft identification (in 8 characters) obtained from an aircraft equipped with a Mode S transponder.

**Format:** Six-octet fixed length Data Item.

**Structure:**

Octet no. 1						Octet no. 2									
48	47	46	45	44	43	42	41	40	39	38	37	36	35	34	33
MSB Character 1						Character 2						Character 3			
Octet no. 3						Octet no. 4									
32	31	30	29	28	27	26	25	24	23	22	21	20	19	18	17
Character 4						Character 5									
Octet no. 5						Octet no. 6									
16	15	14	13	12	11	10	9	8	7	6	5	4	3	2	1
Character 6						Character 7						Character 8 LSB			

bits-48/1

Characters 1-8 (coded on 6 bits each) defining aircraft identification when flight plan is available or the registration marking when no flight plan is available.

**Encoding Rule:**

After the first extraction of aircraft identification, this item shall be present in every ASTERIX record conveying data related to a Mode S target. Bit-48 is the MSB of character 1. Bit-1 is the LSB of character 8.

**5.2.27 Data Item I007/250, Mode S MB Data**

**Definition:** Mode S Comm B data as extracted from the aircraft transponder.  
**Format:** Repetitive Data Item starting with a one-octet Field Repetition Indicator (REP) followed by at least one BDS report comprising one seven octet BDS register and one octet BDS code.  
**Structure:**

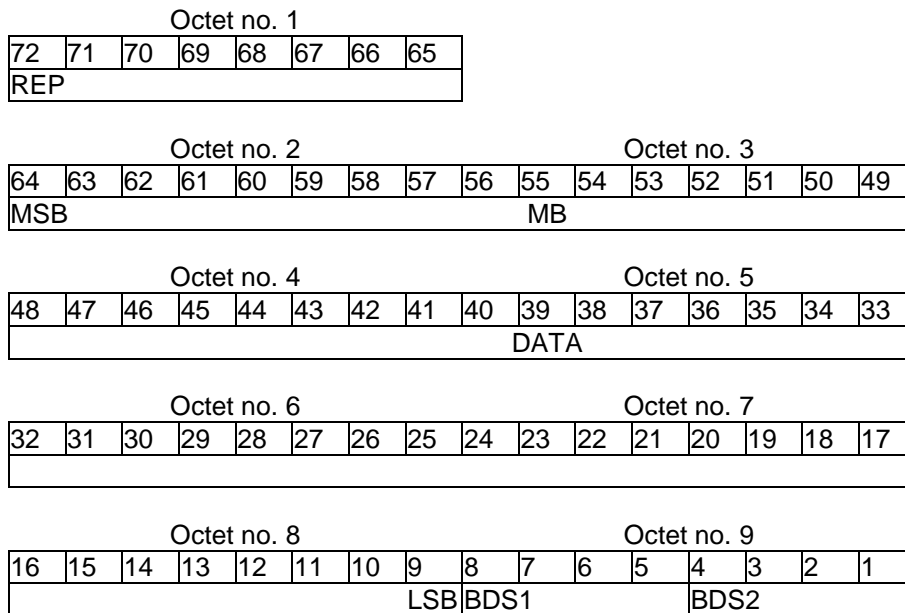

bits-72/65	(REP)	Repetition factor
bits-64/9	(MB Data)	56-bit message conveying Mode S Comm B message data
bits-8/5	(BDS1)	Comm B Data Buffer Store 1 Address
bits-4/1	(BDS2)	Comm B Data Buffer Store 2 Address

**Encoding Rule:**

This item shall be present in every ASTERIX record conveying data related to a Mode S target, provided BDS data has been extracted in the last scan.

**NOTES**

1. For the transmission of BDS20, item 240 is used.
2. For the transmission of BDS30, item 260 is used.
3. In case of data extracted via Comm-B broadcast, all bits of fields BDS1 and BDS2 are set to 0; in case of data extracted via GICB requests, the fields BDS1 and BDS2 correspond to the GICB register number.

**5.2.28 Data Item I007/260, ACAS Resolution Advisory Report**

**Definition:** Currently active Resolution Advisory (RA), if any, generated by the ACAS associated with the transponder transmitting the report and threat identity data.

**Format:** Seven-octet fixed length Data Item.

**Structure:**

Octet no. 1							Octet no. 2								
56	55	54	53	52	51	50	49	48	47	46	45	44	43	42	41

Octet no. 3							Octet no. 4								
40	39	38	37	36	35	34	33	32	31	30	29	28	27	26	25
MB DATA															

Octet no. 5							Octet no. 6								
24	23	22	21	20	19	18	17	16	15	14	13	12	11	10	9

Octet 7							
8	7	6	5	4	3	2	1

bits-56/1 (MB Data)

56-bit message conveying Mode S  
 Comm B message data of BDS  
 Register 3,0.

**Encoding Rule:**

This item shall be present when a Resolution Advisory has been generated in the last scan.

**NOTES**

1. Refer to ICAO Draft SARPs for ACAS for detailed explanations.

### 5.2.29 Data Item I007/400, Directed Interrogation Request Number

**Definition** Directed Interrogation Request Number  
**Format** Two-octet fixed length Data Item

**Structure**

Octet no. 1								Octet no. 2							
16	15	14	13	12	11	10	09	08	07	06	05	04	03	02	01
PRI	Request Number													LSB	

Bit-16 (PRI) Priority of Command  
 =0 Normal Priority, surveillance function has priority  
 =1 High Priority, Directed interrogation has priority over surveillance  
 bit 15/1 Request Number

**Encoding Rules** This Data Item shall be sent for all messages related to directed interrogations.

- Notes**
1. The Request Number is created by the client, which directs the sensor to perform an interrogation.
  2. The sensor will use the same request number for all subsequent messages related to the respective directed interrogation.
  3. The sensor will not accept a request number which is currently processed.
  4. In some cases (e.g. overlapping of directed interrogation windows with partially equal mode combinations) the sensor cannot determine which request number to assign to target reports due to ambiguity. In this case one matching request number will be used and the sensor has to generate an "ambiguous acknowledge" message when accepting the command.
  5. A value of 0 for the Request Number will cause an Interrogation reject by the sensor. Therefore the Request Number shall always be greater than or equal to 1.

### 5.2.30 Data Item I007/410, Directed Interrogation Message Type

**Definition** Directed Interrogation Message Type

**Format** One octet fixed length Data Item

**Structure** Octet no. 1

08	07	06	05	04	03	02	01
M	e	s	s	a	g	e	T y p e

Bit-8/1 (Type) The message Type of a Directed Interrogation

**Encoding Rules** This Data Item has to be sent for all messages related to directed interrogations.

Type	Description
0	Acknowledge
1	Reject
2	Interrogation Finished
3	Interrogation Completed
4	Target Report
5	Interrogation Request Type A
6	Interrogation Request Type B
7	Interrogation Request Type C
8	Selective BDS-Register Request

- Notes**
- Using the Acknowledge the sensor will confirm the receipt of the directed interrogation command.
  - After the sensor has completed the interrogation, i.e. the interrogations are transmitted, the sensor will report an Interrogation Finished message.
  - When no further targets for a directed interrogation are expected, an Interrogation Completed message will be issued by the interrogator.
  - Although each Directed Interrogation should result in exactly one target report, cases may occur resulting in error conditions. These potential error conditions are signalled with item I007/030.

### 5.2.31 Data Item I007/415, Required Interrogation Modes

**Definition:** Directed Interrogation MIPs.

**Format:** Compound Data Item, comprising of a primary subfield of one octet, followed by one of the defined subfields.

**Structure of Primary Subfield:**

Octet no. 1							
8	7	6	5	4	3	2	1
0	0	0	0	0	RIM	MIPT	FX

bits 8 - 4 Spare bits, set to 0

bit-3 (RIM) Subfield #1: Required Interrogation Modes  
=0 Absence of Subfield #1  
=1 Presence of Subfield #1

bit-2 (MIPT) Subfield #2: MIP Table  
=0 Absence of Subfield #2  
=1 Presence of Subfield #2

bit-1 (FX) Field Extension Indicator  
=0 End of primary subfield  
=1 Extension into next octet

**Structure of Subfield #1:  
Specific MIP:**

Octet no. 1								Octet no. 2							
48	47	46	45	44	43	42	41	40	39	38	37	36	35	34	33
0	0	0	0	0	0	0	LO	MS PROB			M5 FORMAT				
Octet no. 3								Octet no. 4							
32	31	30	29	28	27	26	25	24	23	22	21	20	19	18	17
M4CS		M5S	SM5S	SM54	SM5C	SM53	SM52	SM51	0	M5	RCMA	RCMC	CMC	CM3A	MS
Octet no. 5								Octet no. 6							
16	15	14	13	12	11	10	09	08	07	06	05	04	03	02	01
M4S	SMC	SM3A	SM2	SM1	MCo	M3o	MCS	M3S	MD	MC	MB	M4	M3A	M2	M1

Bit	Interlaced Interrogation Mode	Interrogation Mode Explanation (clarification only)
bit-1	(M1) MODE_1	P1 P2 P3, 2µs P1-P3 spacing
bit-2	(M2) MODE_2	P1 P2 P3, 5µs P1-P3 spacing
bit-3	(M3A) MODE_3A	P1 P2 P3, 8µs P1-P3 spacing
bit-4	(M4) MODE_4	P1 P2 P3 P4 P5 (M4)
bit-5	(MB) MODE_B	P1 P2 P3, 17µs P1-P3 spacing
bit-6	(MC) MODE_C	P1 P2 P3, 21µs P1-P3 spacing
bit-7	(MD) MODE_D	P1 P2 P3, 25µs P1-P3 spacing
bit-8	(M3S) MODE_3A_S	P1 P2 P3 LP4 (intermode A long P4)
bit-9	(MCS) MODE_C_S	P1 P2 P3 LP4 (intermode C long P4)
bit-10	(M3o) MODE_3A_ONLY	P1 P2 P3 SP4 (intermode A short P4)
bit-11	(MCo) MODE_C_ONLY	P1 P2 P3 SP4 (intermode C short P4)
bit-12	(SM1) SUPERMODE_1	M4 succeeded by P1 P2 P3, 2µs P1-P3 spacing
bit-13	(SM2) SUPERMODE_2	M4 succeeded by P1 P2 P3, 5µs P1-P3 spacing
bit-14	(SM3A) SUPERMODE_3A	M4 succeeded by P1 P2 P3, 8µs P1-P3 spacing
bit-15	(SMC) SUPERMODE_C	M4 succeeded by P1 P2 P3, 21µs P1-P3 spacing
bit-16	(M4S) M4_SUPERMODE_	Mode 4 superimposed to current MIP, if not possible raise "reject, unable to process" in item I007/030
bit-17	(MS) MODE_S	UF11 (all-call)
bit-18	(CM3A) COMBINED_3A	UF11 succeeded by P1 P2 P3, 8µs P1-P3 spacing
bit-19	(CMC) COMBINED_C	UF11 succeeded by P1 P2 P3, 21µs P1-P3 spacing
bit-20	(RCMC) MODE S ROLL_CALL	Mode S UF4
bit-21	(RCMA) MODE S ROLL_CALL	Mode S UF5
bit-22	(M5) MODE_5	
bit-23	spare bit, set to 0	
bit-24	(SM51) M5_SUPERMODE_1	
bit-25	(SM52) M5_SUPERMODE_2	
bit-26	(SM53) M5_SUPERMODE_3A	
bit-27	(SM5C) M5_SUPERMODE_C	
bit-28	(SM54) M5_SUPERMODE_4	
bit-29	(SM5S) M5_SUPERMODE_S	
bit-30	(M5S) M5_SUPERMODE_S	Mode 5 superimposed to current MIP, if not possible raise "reject, unable to process" in item I007/030
bit-31 – 32 (M4CS)	Mode 4 Code Selection 00 <sub>b</sub> = Code A 01 <sub>b</sub> = Code B 10 <sub>b</sub> = Defined by sensor	
bit-33 – 37	Mode 5 Interrogation Format if Mode 5 or Mode 5 Supermode is used (M5 FORMAT) (0 .. 9 level 1, 16 .. 23 level 2) otherwise ignored	



bit-38 – 40 (MS PROB)	Probability of Reply if Mode S UF11 or Combined Modes are used 000 <sub>b</sub> = 1 001 <sub>b</sub> = 1/2 010 <sub>b</sub> = 1/4 011 <sub>b</sub> = 1/8 100 <sub>b</sub> = 1/16
bit-41 (LO)	Lockout override = 0 no lockout override = 1 lockout override
bits 42 – 48	Spare, set to 0

**Structure of Subfield #2:  
MIP Table used**

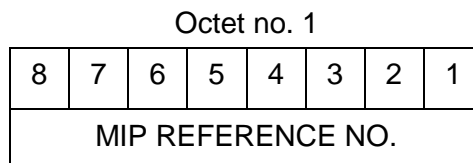

bits 8-1 (MIP No.)      Reference Number in MIP Table

**Encoding Rule:**

This item is optional for all types of Interrogation Request Messages, as depicted in the table of chapter 6.7.

Either subfield #1 or subfield#2 shall be sent.

**Notes:**

- Using different Mode Interlace Pattern Bit Combinations (subfield #1) or Reference Table Numbers (subfield #2) the client can determine the type of interrogation that shall be performed by the sensor for the commanded Directed Interrogation.
- In the case subfield #1 is transmitted the bit combination defines the required modes to be interrogated by the commanded sensor. In case the sensor is not able to interrogate the requested Mode Interlace Pattern, it shall reject the Directed Interrogation with cause 2 (Reject, Unable to process).
- In case the commanding client knows the interlace pattern reference table of the commanded sensor, subfield #2 is sent to directly request the Mode Interlace Pattern by number.
- The bit combination defines the modes at least to be interrogated, information to be retrieved respectively. The exact implementation and further parameters of the Mode Interlace Pattern (PRF, multiple repetition of individual Modes, Tx/Rx times, hits per beam dwell,...) are not subject to control and design/configuration decision within the sensor.
- In case the sensor uses a pre-defined interlace pattern reference table and the table is known to the client, the client shall be able to directly request to use a certain Mode Interlace Pattern by commanding the Mode Interlace Pattern Reference Table Number.

### 5.2.32 Data Item I007/420, Directed Interrogation Window

**Definition** Geographical window defined in polar co-ordinates  
**Format** Eight-octet fixed length Data Item  
**Structure**

Octet no. 1								Octet no. 2							
64	63	62	61	60	59	58	57	56	55	54	53	52	51	50	49
RHO-START															LSB

Octet no. 3								Octet no. 4							
48	47	46	45	44	43	42	41	40	39	38	37	36	35	34	33
RHO-END															LSB

Octet no. 5								Octet no. 6							
32	31	30	29	28	27	26	25	24	23	22	21	20	19	18	17
THETA-START															LSB

Octet no. 7								Octet no. 8							
16	15	14	13	12	11	10	09	08	07	06	05	04	03	02	01
THETA-END															LSB

bit-49 (LSB) = 1/256 NM, Max. Range = 256 NM  
 bit-33 (LSB) = 1/256 NM, Max. Range = 256 NM  
 bit-17 (LSB) =  $360/(2^{16}) = \text{approx. } 0.0055^\circ$   
 bit-1 (LSB) =  $360/(2^{16}) = \text{approx. } 0.0055^\circ$

**Encoding Rules** This Data Item is optional.

- Notes**
1. When present, this window defines the area which should be interrogated and for which target reports are expected.
  2. The sensor shall use this window to determine the azimuth range for the directed interrogation.
  3. The sensor may use this window to tag the extracted targets within this window with the request number.
  4. In case multiple request windows overlap, the sensor may respond with an Ambiguous Acknowledge. It shall be noted, that internally generated expectation windows for directed interrogations related to targets/tracks may also lead to Ambiguous Acknowledge Responses.
  5. The target window is meant within a NE related coordinate system with the point of origin at the radar head.

### 5.2.33 Data Item I007/440, Directed Interrogation BDS Register Request

**Definition** Directed Interrogation BDS Register Request  
**Format** Repetitive Data Item starting with a one-octet Field Repetition Indicator (REP) followed by at least one one-octet Field describing the BDS register to be interrogated.

**Structure**

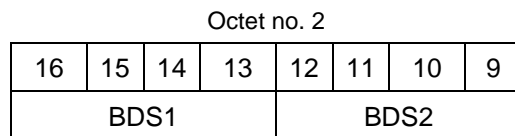
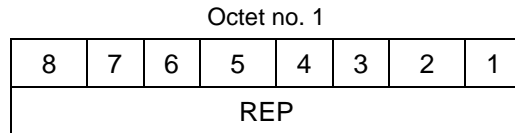

bits 8/1 (REP) Repetition Factor

bit-16/13 (BDS1) Comm B Data Buffer Store 1 Address

bit-12/9 (BDS2) Comm B Data Buffer Store 2 Address

**Encoding Rules** This Data Item is optional. In order to use this Data Item, the Mode S address of the aircraft needs to be known and has to be included via Data Item I007/220.

**Notes** A Directed Interrogation BDS request will only be performed once. If it is not successful it will not be repeated automatically but has to be re-ordered.

**5.2.34 Data Item I007/450, Directed Interrogation Result**

**Definition** Directed Interrogation Result  
**Format** Compound Data Item, comprising a primary subfield of one octet, followed by defined subfields

**Structure Primary Subfield:**

Octet no. 1

08	07	06	05	04	03	02	01
TR	M4	M5	MS	MX	SMS	0	FX

- bit-8 (TR) Subfield #1: Truncation  
= 0 Absence of Subfield #1  
= 1 Presence of Subfield #1
- bit-7 (M4) Subfield #2: Mode 4 Interrogations  
= 0 Absence of Subfield #2  
= 1 Presence of Subfield #2
- bit-6 (M5) Subfield #3: Mode 5 Interrogations  
= 0 Absence of Subfield #3  
= 1 Presence of Subfield #3
- bit-5 (MS) Subfield #4: Mode S All Call Interrogations  
= 0 Absence of Subfield #4  
= 1 Presence of Subfield #4
- bit-4 (MX) Subfield #5: Mark X Interrogations  
= 0 Absence of Subfield #5  
= 1 Presence of Subfield #5
- bit-3 (SMS) Subfield #6: Selective Mode S Interrogations  
= 0 Absence of Subfield #6  
= 1 Presence of Subfield #6
- bit-2 spare bit, set to 0
- bit-1 (FX)  
= 0 End of Primary Subfield  
= 1 Extension of Primary Subfield into next octet

**Subfield #1:**

Truncation

Octet no. 1

08	07	06	05	04	03	02	01
0	0	0	0	N	T	A	C

- bit-4 (N) interrogation was Not executed
- bit-3 (T) interrogation scheduler has truncated the All Call request
- bit-2 (A) interrogation scheduler has activated the request at least once
- bit-1 (C) interrogation scheduler has activated the request during all its validity

**Note:** Details about potential truncation of interrogations can be found in reference [5]

**Subfield #2:**

Mode 4 Interrogations

Octet no. 1

08	07	06	05	04	03	02	01
M4_NB							

bit-8/1 (M4\_NB) Number of Mode 4 Interrogations performed for the request

**Subfield #3:**

Mode 5 Interrogations

Octet no. 1

08	07	06	05	04	03	02	01
M5_NB							

bit-8/1 (M5\_NB) Number of Mode 5 Interrogations performed for the request

**Subfield #4:**

Mode S Interrogations

Octet no. 1							Octet no. 2								
16	15	14	13	12	11	10	09	08	07	06	05	04	03	02	01
0	0	0	0	0	0	LO	MS_NB								

bit-10/9 (LO) Lockout  
 00 = No Lockout used by Interrogation Scheduler  
 01 = Lockout used by Interrogation Scheduler  
 10 = Lockout-Override applied

bit-8/1 (MS\_NB) Number of Mode S All Calls performed for the request

**Subfield #5:**

Mark X Interrogations

Octet no. 1							
08	07	06	05	04	03	02	01
MX_NB							

bit-8/1 (MX\_NB) Number of Mark X Interrogations (Mode 1,2,3/A,C) performed for the request

**Subfield #6:**

Selective Mode S Interrogations

Octet no. 1							
08	07	06	05	04	03	02	01
SMS_NB							

bit-8/1 (SMS\_NB) Number of Selective Mode S interrogations performed for the request

**Encoding Rules**

This Data Item has to be present in each ASTERIX message of the type "interrogation finished" (Message type 2)

### 5.3 Transmission of Surveillance Information

Considering the significant difference between the composition of the Direct Interrogation Request messages (Uplink) and the corresponding responses (Downlink), two different UAPs were defined.

The “Downlink-UAP” applies to the message types 0 to 4 as defined in item I007/410.

The “Uplink-UAP” defines the composition of the messages according to message types 5 to 8 as defined in item I007/410.

#### 5.3.1 Standard User Application Profile “Downlink”

The following standard UAP shown in Table 2 shall be used for the transmission of responses to Direct Interrogations. This UAP applies to the following message types as encoded in item I007/410:

- 0 - DI Acknowledge
- 1 - DI Reject
- 2 - DI Finished
- 3 - DI Completed
- 4 - Target Report

The encoding rules for each individual item in every type of message are detailed in chapter 6.7

**Table 2 - Standard UAP “Downlink”**

FRN	Data Item	Data Item Description	Length in Octets
1	I007/010	Data Source Identifier	2
2	I007/025	Data Destination Identifier	2
3	I007/410	Directed Interrogation Message Type	1
4	I007/140	Time-of-Day	3
5	I007/400	Directed Interrogation Request Number	2
6	I007/020	Target Report Descriptor	1+
7	I007/040	Measured Position in Slant Polar Coordinates	4
FX	n.a.	Field Extension Indicator	n.a.
8	I007/070	Mode-3/A Code in Octal Representation	2
9	I007/090	Flight Level in Binary Representation	2
10	I007/130	Radar Plot Characteristics	1+1+
11	I007/220	Aircraft Address	3
12	I007/240	Aircraft Identification	6
13	I007/250	Mode S MB Data	1+8*n
14	I007/161	Track Number	2
FX	n.a.	Field Extension Indicator	n.a.
15	I007/042	Calculated Position in Cartesian Coordinates	4
16	I007/200	Calculated Track Velocity in Polar Representation	4
17	I007/170	Track Status	1+
18	I007/210	Track Quality	4
19	I007/030	Warning/Error Conditions	1+

20	I007/080	Mode-3/A Code Confidence Indicator	2
21	I007/100	Mode-C Code and Confidence Indicator	4
FX	n.a.	Field Extension Indicator	n.a.
22	I007/110	Height Measured by 3D Radar	2
23	I007/120	Radial Doppler Speed	1+
24	I007/230	Communications / ACAS Capability and Flight Status	2
25	I007/260	ACAS Resolution Advisory Report	7
26	I007/055	Mode-1 Code in Octal Representation	1
27	I007/050	Mode-2 Code in Octal Representation	2
28	I007/065	Mode-1 Code Confidence Indicator	1
FX	n.a.	Field Extension Indicator	n.a.
29	I007/060	Mode-2 Code Confidence Indicator	2
30	I007/450	Directed Interrogation Result	1+
31	I007/085	Mode 5, extended Mode 1, X-Pulse	1+
32	-	Unused	-
33	-	Unused	-
34	SPF	Special Purpose Field	1+1+
35	REF	Reserved Expansion Field	1+1+
FX	n.a.	Field Extension Indicator	n.a.

In the above table

- the first column indicates the Field Reference Number (FRN) associated to each Data Item used in the UAP;
- the fourth column gives the format and the length of each item, a stand-alone figure indicates the octet-count of a fixed-length Data Item, 1+ indicates a variable-length Data Item comprising a first part of 1 octet followed by n-octets extents as necessary.



### 5.3.2 Standard User Application Profile “Uplink”

The UAP described hereafter applies to all messages transmitted to initiate the Direct Interrogation (Uplink).

In detail, the following UAP is applied to the message types

- 5 - DI Request Type A (Position)
- 6 - DI Request Type B (Window)
- 7 - DI Request Type C (Track-Number)
- 8 - DI Request for selected BDS-Register

The encoding rules for the individual items in each type of message are detailed in chapter 6.7.

**Table 3 - Standard UAP “Uplink”**

FRN	Data Item	Data Item Description	Length in Octets
1	I007/010	Data Source Identifier	2
2	I007/025	Data Destination Identifier	2
3	I007/410	Directed Interrogation Message Type	1
4	I007/140	Time-of-Day	3
5	I007/400	Directed Interrogation Request Number	2
6	I007/040	Measured Position in Slant Polar Coordinates	4
7	I007/220	Aircraft Address	3
FX	n.a.	Field Extension Indicator	n.a.
8	I007/161	Track Number	2
9	I007/042	Calculated Position in Cartesian Coordinates	4
10	I007/200	Calculated Track Velocity in Polar Representation	4
11	I007/415	Required Interrogation Modes	1+
12	I007/420	Directed Interrogation Window	8
13	I007/440	Directed Interrogation BDS Register Request	1+
14	-	Unused	-
FX	n.a.	Field Extension Indicator	n.a.
15	-	Unused	-
16	-	Unused	-
17	-	Unused	-
18	-	Unused	-
19	-	Unused	-
20	SPF	Special Purpose Field	1+1+
21	REF	Reserved Expansion Field	1+1+
FX	n.a.	Field Extension Indicator	n.a.

## 6. ENCODING RULES FOR DIRECTED INTERROGATION MESSAGES

The following rules define which Data Items are required for the different message types related to directed interrogations and which system the message is addressed to.

To apply the Directed Interrogation message types 5, 6 and 7 the client has to ask for a specific position to be interrogated. Three different ways of specifying the position of the target to be interrogated have been identified (communicated in item I007/410):

- The Directed Position Interrogation as defined in chapter 6.1;
- The use of a Directed Interrogation Window, described in chapter 6.2 and
- The Directed Addressing of a specific track-number as described in chapter 6.3.

Besides the standard ASTERIX data items I007/010 (Data Source Identifier), I007/025 (Data Destination Identifier) and I007/140 (Time of Day) the following Data Items are mandatory for each type of Directed Interrogation: "Directed Interrogation Request Number (I007/400)", "Directed Interrogation Message Type (I007/410)" and "Required Interrogation Modes (I007/415)".

The following encoding rules describe the usage of the optional Data Items.

The table in paragraph 6.7 summarizes for each message type the mandatory, optional and not allowed Data Items.

### 6.1 Directed Position Interrogation (A) – Message Type 5

To request a specific interrogation program to be used on a specific position the client has to send a Cat007 message containing:

- the Position (Data Item I007/040, mandatory) in polar coordinates to be interrogated relative to a fix reference point on the interrogator platform
- the Time of Day (Data Item I007/140, mandatory) containing the time for which the given position is valid
- the Calculated Position (Data Item I007/042, mandatory) in X/Y coordinates to be interrogated relative to a fix reference point on the platform (it is necessary to evaluate the height of the target for a correct 3D co-ordinate transformation in the case of a moving platform)
- the Calculated Track Velocity (Speed and Heading, Data Item I007/200, optional) indicating the movement direction and speed of the target, if not transmitted a stationary target is expected.

The Position (I007/040) to be interrogated is given in relative polar coordinates to the platform. Due to the possible movement of the platform it is only valid at a specific point of time as indicated in the Time of Day (I007/140).

## 6.2 Directed Interrogation Window (B) – Message Type 6

To request a specific interrogation program to be used on a specific interrogation window the client has to send a Cat007 message containing:

- the Directed Interrogation Window (Data Item I007/420, mandatory) containing the borders of the window to be interrogated
- the Time of Day (Data Item I007/140, mandatory) containing the time for which the given window is valid

The client must not send neither the Position (I007/040) nor the Calculated Position (I007/042) to not confuse this type of directed interrogation with the Directed Position Interrogation. As with the Directed Position Interrogation the given interrogation window is only valid at a specific point of time as indicated in the Time of Day (I007/140).

## 6.3 Directed Track-Number Interrogation (C) – Message Type 7

To request a specific interrogation program to be used on a specific target identified by its track number the client has to send a Cat007 message containing:

- the Track Number (Data Item I007/161, mandatory) identifying the target to be interrogated

The client must not send neither the Position (I007/040) nor the Calculated Position (I007/042) nor the Directed Interrogation Window (I007/420) to not confuse this type of directed interrogation with the Directed Position Interrogation (A) and the Directed Interrogation Window (B). The position and the interrogation window forecasted by the internal tracker will be used for the interrogation and will be corrected with respect to the most current motion compensation information.

## 6.4 Selective BDS-Request – Message Type 8

This message type allows the interrogator to request the contents of BDS-registers of a specific target identified by its Mode S address without indicating the target's position. Based on the internal track database, the interrogator itself will determine the position of the target to be interrogated. A Cat007 message type 8 must therefore contain:

- the Aircraft Address (Data Item I007/220, mandatory) containing the unique 24 bit address of the aircraft to be interrogated
- The BDS Register Number (Data Item I007/440, mandatory) containing the number of the register to be retrieved

## **6.5 Reasons for Ambiguous Acknowledge**

An Ambiguous Acknowledge for an Interrogation Request will be received by the client if (and only if) the sensor is not able to decide which answer was caused by which request number (request number in the reply is un-decidable). These cases can only occur if there are:

- overlapping interrogation windows
- interrogation requests for the same Mode S address
- interrogation requests containing the same track number

The actual reason for an ambiguous acknowledge is signalled with item I007/030

## **6.6 Limit for number of Directed Interrogation Requests**

In order to not compromise the surveillance operation of the sensor, a limit may be applied to the number of Directed Interrogations per scan. This limit is a system specific parameter.

If this limit is exceeded, the proper indication in item I007/030 will be sent.

### 6.7 Summary

Message Type	Interrogation Request				Interrogation Acknowledge	Interrogation Reject	Interrogation Finished	Target Report	Interrogation Completed
	A	B	C	BDS					
I007/410	5	6	7	8	0	1	2	4	3
Intended Recipient	Sensor				Client	Client	Client	Client	Client
I007/010	M	M	M	M	M	M	M	M	M
I007/025	M	M	M	M	M	M	M	M	M
I007/410	M	M	M	M	M	M	M	M	M
I007/140	M	M	M	M	M	M	M	M	M
I007/400	M	M	M	M	M	M	M	M	M
I007/020	-	-	-	-	-	-	-	M	-
I007/040	M	-	-	-	-	-	-	O (*)	-
I007/070	-	-	-	-	-	-	-	O (*)	-
I007/090	-	-	-	-	-	-	-	O (*)	-
I007/130	-	-	-	-	-	-	-	O	-
I007/220	O	O	O	M	-	-	-	O (*)	-
I007/240	-	-	-	-	-	-	-	O (*)	-
I007/250	-	-	-	-	-	-	-	O (*)	-
I007/161	-	-	M	-	-	-	-	O (*)	-
I007/042	M	-	-	-	-	-	-	O	-
I007/200	O	-	-	-	-	-	-	O (*)	-
I007/170	-	-	-	-	-	-	-	O (*)	-
I007/210	-	-	-	-	-	-	-	O	-
I007/030	-	-	-	-	O	O	O	O	O
I007/080	-	-	-	-	-	-	-	O	-
I007/100	-	-	-	-	-	-	-	O	-
I007/110	-	-	-	-	-	-	-	O	-
I007/120	-	-	-	-	-	-	-	O	-
I007/230	-	-	-	-	-	-	-	O (*)	-
I007/260	-	-	-	-	-	-	-	O	-
I007/055	-	-	-	-	-	-	-	O	-
I007/050	-	-	-	-	-	-	-	O	-
I007/065	-	-	-	-	-	-	-	O	-
I007/060	-	-	-	-	-	-	-	O	-
I007/085	-	-	-	-	-	-	-	O	-
I007/415	O	O	O	O	-	-	-	-	-
I007/420	-	M	-	-	-	-	-	-	-
I007/440	O	O	O	M	-	-	-	-	-
I007/450	-	-	-	-	-	-	M	-	O
SP-Data Item	-	-	-	-	-	-	-	O	-
RE-Data Item	-	-	-	-	-	-	-	O	-

M = Mandatory O = Optional - = not allowed  
(\* ) = check detailed encoding rules listed with the item definition

## **7. IMPLEMENTATION EXAMPLE**

### **7.1 General**

The way Directed Interrogations are implemented is application specific. The contents of this chapter may serve as an example for a possible realisation. Other implementations, making use of none, some or all aspects described hereafter are possible as well.

### **7.2 Interrogation Requests**

The directed interrogation requests initiate the processing of directed interrogations. Upon receipt, the sensor is obliged to check the interrogation requests and shall instantly send an acknowledge or a reject message in order to inform the client about the processing of such a message.

In order to be taken into account the Directed Interrogation Request must be sent some time (which is a system parameter) before the antenna passes the given Directed Interrogation Window or the target to be interrogated. If the Directed Interrogation is sent too late it will be performed (if acknowledged) during the following scan.

### **7.3 Interrogation Acknowledges**

Upon receipt of an interrogation request a sensor checks the received message. In case the message can be properly processed, a respective acknowledge will be returned to the client. In case multiple requests are pending and the sensor expects ambiguity for the returned targets, the sensor shall report this in the acknowledge. Ambiguity may result from multiple requests for the same target, or overlapping expectation windows.

Ambiguity may affect any previous interrogation command, even though it was acknowledged before without an indication of ambiguity. The client system is responsible for either distinguishing these cases or ensuring that ambiguity is avoided.

Directed Interrogation Ambiguities arise due to overlapping interrogation windows, in which IFF Interrogation Modes are (at least partially) the same. E.g. a Directed Interrogation window in which one target is interrogated with modes 1, 2 and 3/A and another Directed Interrogation window in which another target is interrogated with modes 1 and 2. Therefore responses (target reports) with the shared IFF Modes from targets might be difficult to assign to the correct interrogation request number. In this case the most probable request number will be used. E.g. both targets from aforementioned example answer only in Mode 1 and 2. Then it is unclear for which interrogation request number the target report was received. However the target reports data, except for the interrogation request number I007/400, is always as correct as possible within secondary radar technology limitations.

If ambiguity is detected when a new Directed Interrogation request arrives, then the sensor has to generate an "ambiguous acknowledge" message when accepting the new Directed

Interrogation command. The client is then responsible for assigning the resulting target reports to the right target in its internal processing.

These cases as described above are considered as error-events which are signalled in data item I007/030.

#### **7.4 Interrogation Finished**

The Interrogation Finished message will be generated by the sensor, as soon as the target interrogation has been transmitted into the air. It shall be noted, that depending on the geometry of a directed interrogation, i.e. the azimuthal extent of an expectation window, the Interrogation Finished message may arrive after the first target reports related to this interrogation. Furthermore, target reports may appear after the Interrogation Finished.

#### **7.5 Interrogation Completed**

The Interrogation Completed will be generated by the sensor, when it closes the expectation windows for a directed interrogation. After this message no further target reports related to the particular directed interrogation will appear. Nevertheless, ambiguity caused by the respective command (Interrogation Request that was accepted with an ambiguous acknowledge) may occur.

### 7.6 Protocol visualized

