



# EUROCONTROL Specification for Surveillance Data Exchange ASTERIX Part 32 Category 237

Aeronautical Data Messages

**Note: This Edition is NOT backwards compatible to Category 237 Edition 1.0**

Edition: 1.1  
Edition date: 07-04-2025  
Status: Released Issue  
Intended for: General Public  
Category: EUROCONTROL Specification



NETWORK  
MANAGER



## DOCUMENT CHARACTERISTICS

TITLE			
<b>EUROCONTROL Specification for Surveillance Data Exchange – ASTERIX Part 32 Category 237 Aeronautical Data Messages</b>			
<b>Publications Reference:</b>		SPEC-0149-32	
<b>ISBN Number:</b>		978-2-87497-028-3	
<b>Document Identifier</b>		<b>Edition Number:</b> 1.1	
EUROCONTROL-SPEC-0149-32		<b>Edition Date:</b> 07/04/2025	
Abstract			
This document specifies the contents of ASTERIX Category 237 messages used for the transmission of Aeronautical Data Messages. Category 237 is designed to transmit information from a number of different applications such as NOTAMs, SNOWTAMs and similar.			
Keywords			
Data Exchange	Messages	SAC	SIC
Data Category	Data Field	Data Item	Aeronautical Data
ASTERIX	UAP	NOTAM	SNOWTAM
Contact Person(s)		Tel	Unit
Alexander Engel		+32-2-729 3355	ATD/APD/STN

STATUS, AUDIENCE AND ACCESSIBILITY					
Status	Intended for			Accessible via	
Working Draft	<input type="checkbox"/>	General Public	<input checked="" type="checkbox"/>	Intranet	<input type="checkbox"/>
Draft	<input type="checkbox"/>	EUROCONTROL	<input type="checkbox"/>	Extranet	<input type="checkbox"/>
Proposed Issue	<input type="checkbox"/>	Restricted	<input type="checkbox"/>	Internet (www.eurocontrol.int)	<input checked="" type="checkbox"/>
Released Issue	<input checked="" type="checkbox"/>				

## **DOCUMENT APPROVAL**

This document has been approved by the ASTERIX Maintenance Group (AMG).

For management approval of the complete set of ASTERIX documentation refer to Part 1.

## DOCUMENT CHANGE RECORD

The following table records the complete history of the successive editions of the present document.

EDITION	DATE	REASON FOR CHANGE	SECTIONS PAGES AFFECTED
0.1	Sep. 2021	Creation of first draft	ALL
0.2	Apr. 2022	Internal Review	ALL
0.3	Jan. 2023	Migration to EUROCONTROL template	ALL
0.4	Apr. 2024	Changes from EUROCONTROL implemented	ALL
0.5P	Aug. 2024	Submission to AMG	ALL
0.6P	Sep. 2024	Changes from AMG Implemented	ALL
0.7P	Sep. 2024	Changes from AMG Implemented	ALL
0.8P	Oct. 2024	Changes from AMG Implemented	ALL
0.9P	Oct. 2024	Changes from AMG Implemented	ALL
1.0	Oct. 2024	Released Issue	ALL
1.1	Mar. 2025	Encoding Rules updated Structure Primary Subfield adapted to Part 1 Corrected UAP <b>This Edition is not backwards compatible to Edition 1.0</b>	5.1.1 5.1.26 5.2.1

### Publications

EUROCONTROL Headquarters  
96 Rue de la Fusée  
B-1130 BRUSSELS

Tel: +32 (0)2 729 4715  
Fax: +32 (0)2 729 5149  
E-mail: [publications@eurocontrol.int](mailto:publications@eurocontrol.int)

---

**TABLE OF CONTENTS**

<b>DOCUMENT CHARACTERISTICS</b> .....	<b>2</b>
<b>DOCUMENT APPROVAL</b> .....	<b>3</b>
<b>DOCUMENT CHANGE RECORD</b> .....	<b>4</b>
<b>1 INTRODUCTION</b> .....	<b>8</b>
1.1 <b>Scope</b> .....	<b>8</b>
<b>2 References</b> .....	<b>9</b>
2.1 <b>General</b> .....	<b>9</b>
2.2 <b>Reference Documents</b> .....	<b>9</b>
<b>3 Definitions, acronyms and abbreviations</b> .....	<b>10</b>
3.1 <b>Definitions</b> .....	<b>10</b>
3.2 <b>Acronyms and Abbreviations</b> .....	<b>11</b>
<b>4 GENERAL PRINCIPLES</b> .....	<b>12</b>
4.1 <b>General</b> .....	<b>12</b>
4.2 <b>Time Management</b> .....	<b>12</b>
4.3 <b>Unused Bits in Data Items</b> .....	<b>12</b>
4.4 <b>User Application Profile</b> .....	<b>13</b>
4.5 <b>Composition of reports</b> .....	<b>13</b>
<b>5 LAYOUT OF REPORTS</b> .....	<b>14</b>
5.1 <b>Description of Standard Data Items</b> .....	<b>14</b>
5.1.1 Data Item I237/000, Message Type.....	14
5.1.2 Data Item I237/010, Data Source Identifier.....	17
5.1.3 Data Item I237/011, Local Data Source Identifier.....	18
5.1.4 Data Item I237/015, Service Identification.....	19
5.1.5 Data Item I237/020, Message Category.....	20
5.1.6 Data Item I237/030, Error Codes.....	21
5.1.7 Data Item I237/040, Time of Filing.....	22
5.1.8 Data Item I237/050, Message Originator Address.....	23
5.1.9 Data Item I237/060, Message Destination Addresses.....	25
5.1.10 Data Item I237/070, Message Header.....	27
5.1.11 Data Item I237/080, Message to be replaced.....	28
5.1.12 Data Item I237/090, NOTAM Qualifier Q: Flight Information Region (FIR).....	29

---

5.1.13	Data Item I237/100, NOTAM Qualifier Q: NOTAM Code .....	30
5.1.14	Data Item I237/110, NOTAM Qualifier Q: Traffic, Purpose, Scope .....	31
5.1.15	Data Item I237/120, NOTAM Qualifier Q: Vertical Limits & Geographical Reference .....	33
5.1.16	Data Item I237/130, Location Indicator .....	35
5.1.17	Data Item I237/140, Message Activation Time .....	36
5.1.18	Data Item I237/150, Message Cancellation Time .....	37
5.1.19	Data Item I237/160, Day/Time Schedule of actual Activity .....	38
5.1.20	Data Item I237/170, Free Text .....	39
5.1.21	Data Item I237/180, Lower and Upper Limit .....	40
5.1.22	Data Item I237/190, SNOWTAM: Runway Conditions .....	42
5.1.23	Data Item I237/195, SNOWTAM: Friction Measurement Method .....	48
5.1.24	Data Item I237/200, SNOWTAM: Taxiway Conditions .....	49
5.1.25	Data Item I237/210, SNOWTAM: Apron Conditions .....	50
5.1.26	Data Item I237/220, ASHTAM .....	52
5.1.27	Data Item I237/230, BIRDTAM .....	63
5.1.28	Data Item I237/240, METAR / SPECI .....	65
5.1.29	Data Item I237/250, Minimum QNH Forecast .....	85
5.1.30	Data Item I237/260, Message Identification .....	86
<b>5.2</b>	<b>Transmission of Aeronautical Data Messages .....</b>	<b>88</b>
5.2.1	Standard user application profile .....	88

This page is intentionally left blank

## 1 INTRODUCTION

### 1.1 Scope

This document describes the structure for the transmission of Aeronautical Data Messages for various applications such as:

- NOTAM
- SNOWTAM
- ASHTAM
- BIRDTAM
- METAR/SPECI
- Min QNH

Category 237 is intended to provide a format for the transmission of information over ASTERIX Networks or ASTERIX Gateways. This document does not make any specifications regarding the content of the messages. Therefore, this category only serves as a container for the original message formats [2, 3, 4, 5]



## 2 REFERENCES

### 2.1 General

The following Documents and Standards contain provisions which, through references in this text, constitute provisions of this EUROCONTROL Standard Document.

At the time of publication of this EUROCONTROL Standard Document, the editions indicated for the referenced documents and standards were valid.

Any revision of the referenced ICAO Documents shall be immediately taken into account to revise this EUROCONTROL Standard Document.

Revisions of the other referenced documents shall not form part of the provisions of this EUROCONTROL Standard Document until they are formally reviewed and incorporated into this EUROCONTROL Standard Document.

In the case of a conflict between the requirements of this EUROCONTROL Standard Document and the contents of the other referenced documents, this EUROCONTROL Standard Document shall take precedence.

### 2.2 Reference Documents

1. EUROCONTROL Standard SUR.ET1.ST05.2000-STD-01-01. "All Purpose Structured EUROCONTROL Surveillance Information Exchange – ASTERIX", Edition 3.1, Released Issue, November 2021.
2. ICAO Doc. 10066 Aeronautical Information Management, Edition 1, 8 November 2018
3. STANAG 3879 Wildlife Strike Prevention, Edition 8, 26 March 2013
4. ICAO Doc 8896 Manual of Aeronautical Meteorological Practice, Edition 11, 2017
5. Military Aeronautical Information Publication Germany, Gen. 3.5-18, 20 June 2019
6. ICAO Annex 5 - Units of Measurement to be Used in the Air and Ground Services
7. ICAO Doc. 7910/191 - Location Indicators
8. FAA Order 7930.2S – Notices to Airmen 10 January 2019
9. ICAO Appendix 8 – Guidance on the use of the AFS, 19 February 2018
10. ICAO Doc. 8585/207 - Designators for Aircraft Operating Agencies, Aeronautical Authorities and Services, January 2024
11. ICAO Doc 9691 AN/954 - Manual on Volcanic Ash, Radioactive Material and Toxic Chemical Clouds, second Edition 2007
12. METAR explanation – IVAO – International Virtual Aviation Organisation, 28. July 2021

### 3 DEFINITIONS, ACRONYMS AND ABBREVIATIONS

#### 3.1 Definitions

For the purposes of this EUROCONTROL Document, the following definitions shall apply:

- |       |                                  |   |
|-------|----------------------------------|---|
| 3.1.1 | <b>Catalogue of Data Items:</b>  | List of all the possible Data Items of each Data Category describing the Data Items by their reference, structure, size and units (where applicable).                                   |
| 3.1.2 | <b>Data Category:</b>            | Classification of the data in order to permit inter alia an easy identification.  |
| 3.1.3 | <b>Data Field:</b>               | Physical implementation for the purpose of communication of a Data Item, it is associated with a unique Field Reference Number and is the smallest unit of transmitted information.     |
| 3.1.4 | <b>Data Item:</b>                | The smallest unit of information in each Data Category.   |
| 3.1.5 | <b>Data Record:</b>              | A collection of transmitted Data Fields of the same category preceded by a Field Specification field, signalling the presence/absence of the various Data Fields.                       |
| 3.1.6 | <b>User Application Profile:</b> | The mechanism for assigning Data Items to Data Fields, and containing all necessary information which needs to be standardised for the successful encoding and decoding of the reports. |

### 3.2 Acronyms and Abbreviations

For the purposes of this EUROCONTROL Document, the following shall apply:

°	Degree (angle)
<b>AFTN</b>	Aeronautical Fixed Telecommunication Network
<b>AMG</b>	ASTERIX Maintenance Group
<b>ASTERIX</b>	All Purpose STructured Eurocontrol suRveillance Information EXchange
<b>CAT</b>	Data Category
<b>FIR</b>	Flight Information Region
<b>FRN</b>	Field Reference Number
<b>FSPEC</b>	Field Specification
<b>Ft</b>	feet
<b>FX</b>	Field Extension Indicator
<b>ICAO</b>	International Civil Aviation Organization
<b>kn</b>	knot = NM/hour, unit of speed
<b>LEN</b>	Length Indicator
<b>LSB</b>	Least Significant Bit
<b>m</b>	metres
<b>NM</b>	Nautical Mile, unit of distance (1852 metres)
<b>REP</b>	Field Repetition Indicator
<b>s</b>	second, unit of time
<b>SAC</b>	System Area Code
<b>SIC</b>	System Identification Code
<b>SP</b>	Special Purpose Indicator
<b>UAP</b>	User Application Profile (see Definitions)
<b>WGS-84</b>	World Geodetic System 84

## **4 GENERAL PRINCIPLES**

### **4.1 General**

This document describes the application of ASTERIX to Aeronautical Data Messages.

### **4.2 Time Management**

The time-stamping shall comply with ICAO Annex 5 [6].

### **4.3 Unused Bits in Data Items**

Decoders of ASTERIX data shall never assume and rely on specific settings of spare or unused bits. However, in order to improve the readability of binary dumps of ASTERIX records, spare bits in the Data Items shall be set to zero.

#### 4.4 User Application Profile

A single User Application Profile (UAP) is defined and shall be used for Category 237 messages.

The composition of ASTERIX records of Category 237 shall follow the rules for ASTERIX Categories that are created as of Edition 2.2 (or later) of Part 1 of the ASTERIX documentation, chapter 5.2.5.

Data records shall have the following layout.

<b>CAT = 237</b>	<b>LEN</b>	<b>FSPEC</b>	<b>Data Item</b>	<b>Data Item</b>	<b>Data Item</b>
------------------	------------	--------------	------------------	------------------	------------------

Where:

- Data Category (CAT) = 237 is a one-octet field indicating that the ASTERIX Record contains information defined for Aeronautical Data Messages;
- Length Indicator (LEN) is a two-octet field indicating the total length in octets of the ASTERIX Record, including the CAT and LEN fields;
- FSPEC is the Field Specification.

**NOTE** - Blocking of multiple Data Records sharing a single CAT and LEN field pair is not supported for Category 237 ASTERIX Records.

#### 4.5 Composition of reports

Reports shall be composed of Data Items assembled in the order defined by the Field Reference Number (FRN) in the associated UAP.

When sent, items shall always be transmitted in a record with the corresponding FSPEC bits set to one.

## 5 LAYOUT OF REPORTS

### 5.1 Description of Standard Data Items

#### 5.1.1 Data Item I237/000, Message Type

**Definition:** This Data Item allows for a more convenient handling of the messages at the receiver side by further defining the type of transaction.

**Format:** One-octet fixed length Data Item.

**Structure:**

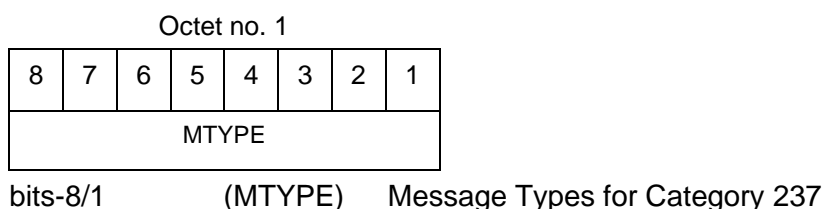

= 000	Error
= 001	NOTAMN
= 002	NOTAMR
= 003	NOTAMC
= 004	CHECKLIST
= 005	SNOWTAM
= 006	Corrected SNOWTAM
= 007	ASHTAM
= 008	Corrected ASHTAM
= 009	BIRDTAM
= 010	METAR
= 011	Corrected METAR
= 012	SPECI
= 013	Corrected SPECI
= 014	MINQNH
= 015–255	Reserved for future use

**Encoding Rule:**

See Table 1 and Table 2

**NOTE** - 1. In applications which exchange transactions of various types, the Message Type Data Item facilitates the proper message handling at the receiver side.

**NOTE - 2.** The encoding rules of Data Items per message type are listed in the following 2 tables.

M stands for mandatory, O for optional, X for never present.

Type Item	000 ERROR	001 NOTAMN	002 NOTAMR	003 NOTAMC	004 CHECKLIST	005 SNOWTAM	006 Corrected SNOWTAM
I237/000	M	M	M	M	M	M	M
I237/010	M	M	M	M	M	M	M
I237/011	O	O	O	O	O	O	O
I237/015	O	O	O	O	O	O	O
I237/020	O	O	O	O	O	O	O
I237/030	M	O	O	O	O	O	O
I237/040	O	O	O	O	O	O	O
I237/050	O	O	O	O	O	O	O
I237/060	O	O	O	O	O	O	O
I237/070	O	M	M	M	M	M	M
I237/080	O	O	M	M	X	X	M
I237/090	O	M	M	M	X	M	M
I237/100	O	M	M	M	X	X	X
I237/110	O	M	M	M	X	X	X
I237/120	O	M	M	M	X	X	X
I237/130	O	O	O	O	X	M	O
I237/140	O	M	M	M	M	M	M
I237/150	O	M	M	M	X	X	X
I237/160	O	O	O	O	X	X	X
I237/170	O	O	O	O	O	O	O
I237/180	O	O	O	O	O	X	X
I237/190	O	X	X	X	X	M	M
I237/195	O	X	X	X	X	O	X
I237/200	O	X	X	X	X	O	X
I237/210	O	X	X	X	X	O	X
I237/220	O	X	X	X	X	X	X
I237/230	O	X	X	X	X	X	X
I237/240	O	X	X	X	X	X	X
I237/250	O	X	X	X	X	X	X
I237/260	O	O	O	O	O	O	O

**Table 1 : Message Types 000 - 006**

Type Item	007 ASHTAM	008 Corrected ASHTAM	009 BIRDTAM	010 METAR	011 Corrected METAR	012 SPECI	013 Corrected SPECI	014 MINQNH
I237/000	M	M	M	M	M	M	M	M
I237/010	M	M	M	M	M	M	M	M
I237/011	O	O	O	O	O	O	O	O
I237/015	O	O	O	O	O	O	O	O
I237/020	O	O	O	O	O	O	O	O
I237/030	O	O	O	O	O	O	O	O
I237/040	O	O	O	O	O	O	O	O
I237/050	O	O	O	O	O	O	O	O
I237/060	O	O	X	O	O	O	O	X
I237/070	M	M	M	X	X	X	X	X
I237/080	X	M	X	X	M	X	M	X
I237/090	M	M	X	X	X	X	X	X
I237/100	X	X	X	X	X	X	X	X
I237/110	X	X	X	X	X	X	X	X
I237/120	X	X	X	X	X	X	X	X
I237/130	X	X	X	M	O	M	O	X
I237/140	M	M	M	X	X	X	X	M
I237/150	X	X	M	X	X	X	X	M
I237/160	X	X	X	X	X	X	X	X
I237/170	O	O	O	O	O	O	O	X
I237/180	M	M	M	X	X	X	X	X
I237/190	X	X	X	X	X	X	X	X
I237/195	X	X	X	X	X	X	X	X
I237/200	X	X	X	X	X	X	X	X
I237/210	X	X	X	X	X	X	X	X
I237/220	M	M	X	X	X	X	X	X
I237/230	X	X	M	X	X	X	X	X
I237/240	X	X	X	M	M	M	M	X
I237/250	X	X	X	X	X	X	X	M
I237/260	O	O	O	O	O	O	O	O

Table 2 : Message Types 007 – 014



### 5.1.2 Data Item I237/010, Data Source Identifier

**Definition:** Identification of the system from which data is received.

**Format:** Two-octet fixed length Data Item.

**Structure:**

Octet no. 1								Octet no. 2							
16	15	14	13	12	11	10	9	8	7	6	5	4	3	2	1
SAC								SIC							

bits-16/9

(SAC)

System Area Code

bits-8/1

(SIC)

System Identification Code

**Encoding Rule:**

See Table 1 and Table 2

**NOTE** - If the System has no associated SAC/SIC Code, the SAC/SIC Code of the server translating the original message into ASTERIX shall be used. The SAC is allocated centrally by EUROCONTROL based on the area. The up-to-date list of SACs is published on the EUROCONTROL ASTERIX website (<http://www.eurocontrol.int/asterix>). Allocation of the SIC is the responsibility of the national authority.

### 5.1.3 Data Item I237/011, Local Data Source Identifier

**Definition:** Identification of the local system from which the data is received.

**Format:** One-octet fixed length Data Item.

**Structure:**

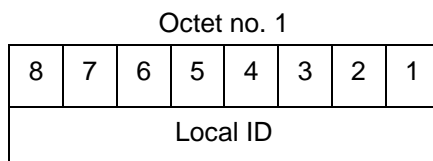

bits-8/1                      (Local ID)        = Local Identifier per SAC/SIC

**Encoding Rule:**

See Table 1 and Table 2

#### 5.1.4 Data Item I237/015, Service Identification

**Definition:** Identification of the service provided to one or more users.

**Format:** One-octet fixed length Data Item.

**Structure:**

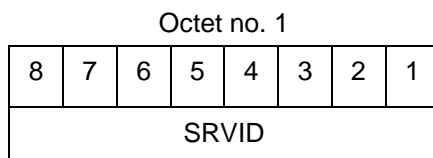

bits-8/1

(SRVID)

Service Identification

**Encoding Rule:**

See Table 1 and Table 2

**NOTE -** The Service Identification is allocated by the system generating the Category 237 Record.

### 5.1.5 Data Item I237/020, Message Category

**Definition:** Category of the message.

**Format:** One-octet fixed length Data Item.

**Structure:**

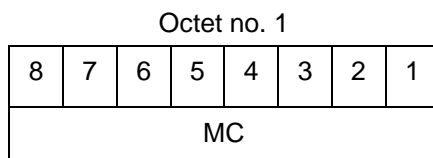

bits-8/1

(MC)

Message Category

= 0 (SS) Distress Message

= 1 (DD) Urgency Message

= 2 (FF) Flight Safety Message

= 3 (GG) Meteorological, Flight  
Regularity, or

Aeronautical Information  
Services Message

= 4 (KK) Aeronautical  
Administrative Message

= 5–255 Reserved for future use

**Encoding Rule:**

See Table 1 and Table 2

**NOTE** - For more information, see ICAO Appendix 8 [9]

**5.1.6 Data Item I237/030, Error Codes**

**Definition:** Error condition detected by the system.

**Format:** Variable length Data Item comprising a first part of one-octet, followed by one-octet extents as necessary.

**Structure:**

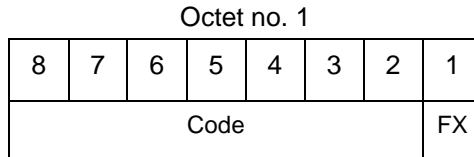

bits-8/2	(Code)	Code describing the information
bit-1	(FX)	Field Extension
		= 0 End of Data Item
		= 1 Extension into next extension (next error condition value)

Code	Decoding
0	Original message could not be transformed into ASTERIX format. The whole message is missing. This code shall be used whenever the NOTAM Header could not be correctly encoded in ASTERIX. In this case, only I237/010 "Data Source Identifier", I237/000 "Message Type" and I237/030 "Error Code" <b>shall</b> be transmitted.
1	Original message could not be correctly transformed into ASTERIX format. This code shall be used whenever the AFTN header could be correctly encoded in ASTERIX. Affected items should be transmitted in I237/090 plain text field.
2	The originating server is off or in an error state. Some or all messages may be lost (primary source down).

**Encoding Rule:**  
See Table 1 and Table 2

**NOTE -** It has to be stressed that a series of one or more codes can be reported per ASTERIX Record.

**NOTE -** Values 0 – 63 are allocated by the AMG, values 64 – 127 are available for allocation by manufacturers and shall be described in the corresponding ICD.

### 5.1.7 Data Item I237/040, Time of Filing

**Definition:** Time when the original report was filed, in seconds since January 1, 2020, 0:00.

**Format:** Four-octet fixed length Data Item.

**Structure:**

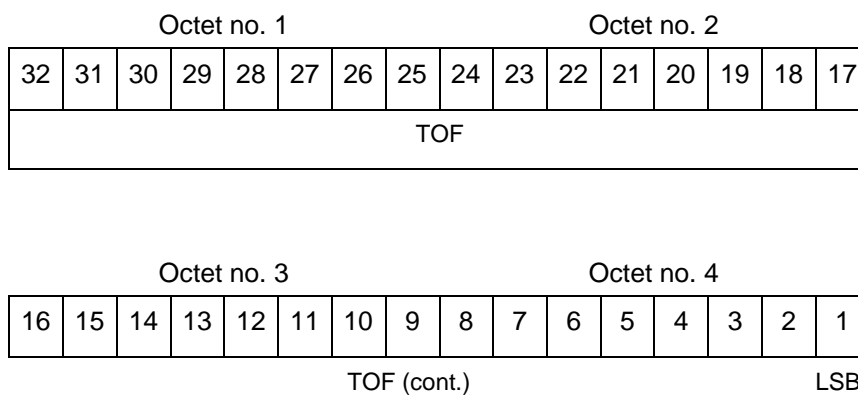

bits-32/1	(TOF)	Time of filing of the original report
bit-1	(LSB)	1 second

**Encoding Rule:**  
See Table 1 and Table 2

### 5.1.8 Data Item I237/050, Message Originator Address

**Definition:** AFTN Address of the message originator.

**Format:** Eight-octet fixed length Data Item.

**Structure:**

Octet no. 1								Octet no. 2							
64	63	62	61	60	59	58	57	56	55	54	53	52	51	50	49
CHAR1								CHAR2							
ORIGIN															

Octet no. 3								Octet no. 4							
48	47	46	45	44	43	42	41	40	39	38	37	36	35	34	33
CHAR3								CHAR4							
ORIGIN (cont.)															

Octet no. 5								Octet no. 6							
32	31	30	29	28	27	26	25	24	23	22	21	20	19	18	17
CHAR5								CHAR6							
ORIGIN (cont.)															

Octet no. 7								Octet no. 8							
16	15	14	13	12	11	10	9	8	7	6	5	4	3	2	1
CHAR7								CHAR8							
ORIGIN (cont.)															

bits-64/1            (ORIGIN)            AFTN Address of the originating service consisting of up to 8 ASCII Characters (A–Z, 0–9) (CHAR1–CHAR8) or 0 as Bit.

**Encoding Rule:**  
See Table 1 and Table 2

- NOTE** - The address is composed of the following information:  
CHAR1–CHAR4: Location indicator (as defined in [7])  
CHAR5–CHAR7: Organisation (as defined in [10])  
CHAR8: Department within organisation
- NOTE** - If a CHAR is not used, it **shall** be set to 0.



### 5.1.9 Data Item I237/060, Message Destination Addresses

**Definition:** AFTN Address of the message Destination.

**Format:** Eight-octet fixed length Data Item.

**Structure:**

Octet no. 1								Octet no. 2							
64	63	62	61	60	59	58	57	56	55	54	53	52	51	50	49
CHAR1								CHAR2							
DEST															

Octet no. 3								Octet no. 4							
48	47	46	45	44	43	42	41	40	39	38	37	36	35	34	33
CHAR3								CHAR4							
DEST (cont.)															

Octet no. 5								Octet no. 6							
32	31	30	29	28	27	26	25	24	23	22	21	20	19	18	17
CHAR5								CHAR6							
DEST (cont.)															

Octet no. 7								Octet no. 8							
16	15	14	13	12	11	10	9	8	7	6	5	4	3	2	1
CHAR7								CHAR8							
DEST (cont.)															

bits-64/1            (DEST)            AFTN Address of the destination  
 NOTAM office consisting of up to 8  
 ASCII Characters (A–Z, 0–9)  
 (CHAR1–CHAR8) or 0 as Bit.

**Encoding Rule:**  
 See Table 1 and Table 2

**NOTE** - The address is composed of the following information:

CHAR1-CHAR4: Location Indicator (as defined in [7])

CHAR5-CHAR7: Organisation (as defined in [10])

CHAR8: Department within organisation

**NOTE** - If a CHAR is not used, it **shall** be set to 0.

**NOTE** - For NOTAM, SNOWTAM and ASHTAM, this can be found in the header as “addresses”.

### 5.1.10 Data Item I237/070, Message Header

**Definition:** Header of the message, containing the serial number, year of publication, and the NOTAM series.

**Format:** Four-octet fixed length Data Item.

**Structure:**

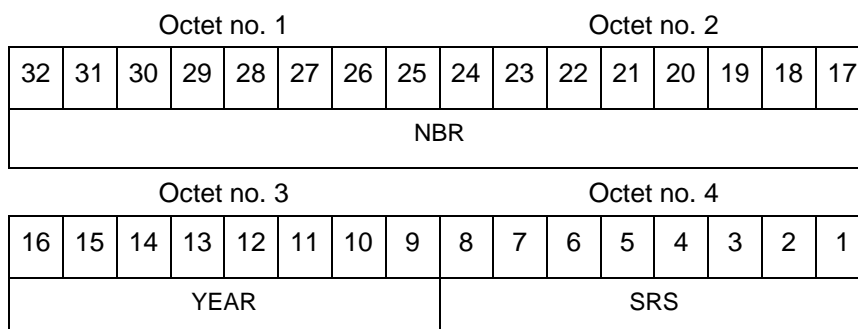

bits-32/17	(NBR)	Serial Number (0-9999)
bits-16/9	(YEAR)	Year of publication (0–99)
bit-16	(YEAR#EP)	Element populated bit =0 Element not populated =1 Element populated
bits-15/9	(YEAR#VAL)	Year value
bits-8/1	(SRS)	NOTAM Series
bit-8	(SRS#EP)	Element populated bit =0 Element not populated =1 Element populated
bits-7/1	(SRS#VAL)	NOTAM Series, ASCII Character (A–Z)

**Encoding Rule:**

See Table 1 and Table 2

**NOTE -** In case of a SNOWTAM (Message Type = 005 or 006) or an ASHTAM (Message Type = 007 or 008), only NBR is used. SRS and YEAR **shall** be set to 0.

**NOTE -** In case of a BIRDTAM (Message Type = 009), only NBR and YEAR are used. SRS **shall** be set to 0.

### 5.1.11 Data Item I237/080, Message to be replaced

**Definition:** Header of the message to be replaced.

**Format:** Four-octet fixed length Data Item.

**Structure:**

Octet no. 1								Octet no. 2							
32	31	30	29	28	27	26	25	24	23	22	21	20	19	18	17
NBR															

Octet no. 3								Octet no. 4							
16	15	14	13	12	11	10	9	8	7	6	5	4	3	2	1
YEAR								SRS							

bits-32/17	(NBR)	Serial Number (0-9999)
bits-16/9	(YEAR)	Year of publication (0-99)
bit-16	(YEAR#EP)	Element populated bit =0 Element not populated =1 Element populated
bits-15/9	(YEAR#VAL)	Year value
bits-8/1	(SRS)	NOTAM Series
bit-8	(SRS#EP)	Element populated bit =0 Element not populated =1 Element populated
bits-7/1	(SRS#VAL)	NOTAM Series, ASCII Character (A-Z)

**Encoding Rule:**

See Table 1 and Table 2

**NOTE -** In case of a NOTAMR message (Message Type = 002), this Data Item shall contain the header of the NOTAM to be replaced.

### 5.1.12 Data Item I237/090, NOTAM Qualifier Q: Flight Information Region (FIR)

**Definition:** FIR as indicated in Item Q of the NOTAM.

**Format:** Four-octet fixed length data item.

**Structure:**

Octet no. 1								Octet no. 2							
32	31	30	29	28	27	26	25	24	23	22	21	20	19	18	17
FIR1								FIR2							
FIR															

Octet no. 3								Octet no. 4							
16	15	14	13	12	11	10	9	8	7	6	5	4	3	2	1
FIR3								FIR4							
FIR (cont.)															

bits-32/1

(FIR)

FIR designator as contained in Item Q of the NOTAM, consisting of four ASCII Characters (A–Z, 0–9) FIR1–FIR4

**Encoding Rule:**

See Table 1 and Table 2

**NOTE -** In case of a SNOWTAM (Message Type = 005 or 006) (Item A) or an ASHTAM (Message Type = 007 or 008), this Data Item **shall** contain the location indicator of the aerodrome concerned.

### 5.1.13 Data Item I237/100, NOTAM Qualifier Q: NOTAM Code

**Definition:** NOTAM Code as indicated in Item Q of the NOTAM.

**Format:** Four-octet fixed length data item.

**Structure:**

Octet no. 1								Octet no. 2							
32	31	30	29	28	27	26	25	24	23	22	21	20	19	18	17
NCODE2								NCODE3							
NCODE															

Octet no. 3								Octet no. 4							
16	15	14	13	12	11	10	9	8	7	6	5	4	3	2	1
NCODE4								NCODE5							
NCODE (cont.)															

bits-32/1            (NCODE)            NOTAM Code as contained in Item Q of the NOTAM. The NOTAM Code consists of the letter Q followed by the four ASCII Characters (A–Z, 0–9) NCODE2–NCODE5 (see note)

**Encoding Rule:**

See Table 1 and Table 2

**NOTE -** A list of Q Codes can be found in Appendix B of [8]

**NOTE -** NCODE1 is always character “Q” and will not be transmitted.

### 5.1.14 Data Item I237/110, NOTAM Qualifier Q: Traffic, Purpose, Scope

**Definition:** Identification of applicable traffic, purpose and scope of the NOTAM.

**Format:** Two-octet fixed length Data Item.

**Structure:**

Octet no. 1								Octet no. 2							
16	15	14	13	12	11	10	9	8	7	6	5	4	3	2	1
TK	PK	SK	TI	TV	PN	PB	PO	PM	SA	SE	SW	0	0	0	0

bit-16	(TK)	Checklist indicator traffic (note 1) = 0 NOTAM is not a checklist = 1 NOTAM is a checklist
bit-15	(PK)	Checklist indicator purpose (note 1) = 0 NOTAM is not a checklist = 1 NOTAM is a checklist
bit-14	(SK)	Checklist indicator scope (note 1) = 0 NOTAM is not a checklist = 1 NOTAM is a checklist
bit-13	(TI)	Applicability for IFR traffic (note 2) = 0 not applicable for IFR traffic = 1 applicable for IFR traffic
bit-12	(TV)	Applicability for VFR traffic (note 2) = 0 not applicable for VFR traffic = 1 applicable for VFR traffic
bit-11	(PN)	immediate attention of aircraft operators = 0 not for immediate attention = 1 for immediate attention
bit-10	(PB)	for pre-flight information briefing = 0 no = 1 yes
bit-9	(PO)	concerning flight operations = 0 no = 1 yes
bit-8	(PM)	miscellaneous NOTAM (note 3) = 0 no = 1 yes

bit-7	(SA)	applicable to aerodrome = 0 not applicable to aerodrome = 1 applicable to aerodrome
bit-6	(SE)	applicable enroute = 0 not applicable enroute = 1 applicable enroute
bit-5	(SW)	navigation warning = 0 contains no navigation warning = 1 contains navigation warning
bits-4/1	(spare)	Spare bits, set to 0

**Encoding Rule:**

See Table 1 and Table 2

**NOTE -** 1. If bit-16 or bit-15 or bit-14 is set to 1, the other two bits **shall** be set to 1 as well.

If bit-16 or bit-15 or bit-14 is set to 1, bits 13/5 **shall** be set to 0.

**NOTE -** 3. This NOTAM is not subject for a briefing but is available upon request.

**NOTE -** 4. T = Traffic (bits-16, 13, 12), P = Purpose (bits-11/8),  
S = Scope (bits-7/5)



### 5.1.15 Data Item I237/120, NOTAM Qualifier Q: Vertical Limits & Geographical Reference

**Definition:** Lower/upper limit and Geographical Reference applicable to NOTAM.

**Format:** Ten-octet fixed length Data Item.

**Structure:**

Octet no. 1										Octet no. 2					
80	79	78	77	76	75	74	73	72	71	70	69	68	67	66	65
LOWER														LSB	

Octet no. 3							Octet no. 4								
64	63	62	61	60	59	58	57	56	55	54	53	52	51	50	49
UPPER															LSB

Octet no. 5							Octet no. 6								
48	47	46	45	44	43	42	41	40	39	38	37	36	35	34	33
LAT															LSB

Octet no. 7							Octet no. 8								
32	31	30	29	28	27	26	25	24	23	22	21	20	19	18	17
LON															LSB

Octet no. 9							Octet no. 10								
16	15	14	13	12	11	10	9	8	7	6	5	4	3	2	1
RADIUS															LSB

bits-80/65	(LOWER)	Lower vertical limit of NOTAM applicability (note 1)
bit-80	(LOWER#EP)	Element Populated Bit (note 2) =0 Lower is not populated =1 Lower is populated
bits-79/65	(LOWER#VAL)	Lower vertical limit in two's complement
bit-65	(LSB)	25 ft

bits-64/49	(UPPER)	Upper vertical limit of NOTAM applicability (note 1)
bit-64	(UPPER#EP)	Element Populated Bit (note 3) =0 Upper is not populated =1 Upper is populated
bits-63/49	(UPPER#VAL)	Upper vertical limit in two's complement
bit-49	(LSB)	25 ft
bits-48/33	(LAT)	Latitude of the geographical position of the point of influence or the centre of the circle defining the area of influence in two's complement. [-90°, 90°] (note 4)
bit-33	(LSB)	1 degree
bits-32/17	(LON)	Longitude of the geographical position of the point of influence or the centre of the circle defining the area of influence in two's complement. [-180°, 179°] (note 5)
bit-17	(LSB)	1 degree
bits-16/1	(RADIUS)	Radius of the circle defining the area of influence
bit-1	(LSB)	0.1 NM

**Encoding Rule:**

See Table 1 and Table 2

**NOTE** - 1. bits-80/49: LOWER ≤ UPPER**NOTE** - 2. If LOWER is not populated, the Lower Limit is unlimited**NOTE** - 3. If UPPER is not populated, the Upper Limit is unlimited.**NOTE** - 4. Negative values represent South, positive values represent North**NOTE** - 5. Negative values represent West, positive values represent East.**NOTE** - 6. For more Information see ICAO Doc. 1066 [2]

### 5.1.16 Data Item I237/130, Location Indicator

**Definition:** Location indicator(s) of the aerodrome or FIR in which the facility, airspace or condition being reported on is located.

**Format:** Repetitive Data Item starting with a one-octet Field Repetition Indicator (REP) followed by at least one location indicator of four octets.

**Structure:**

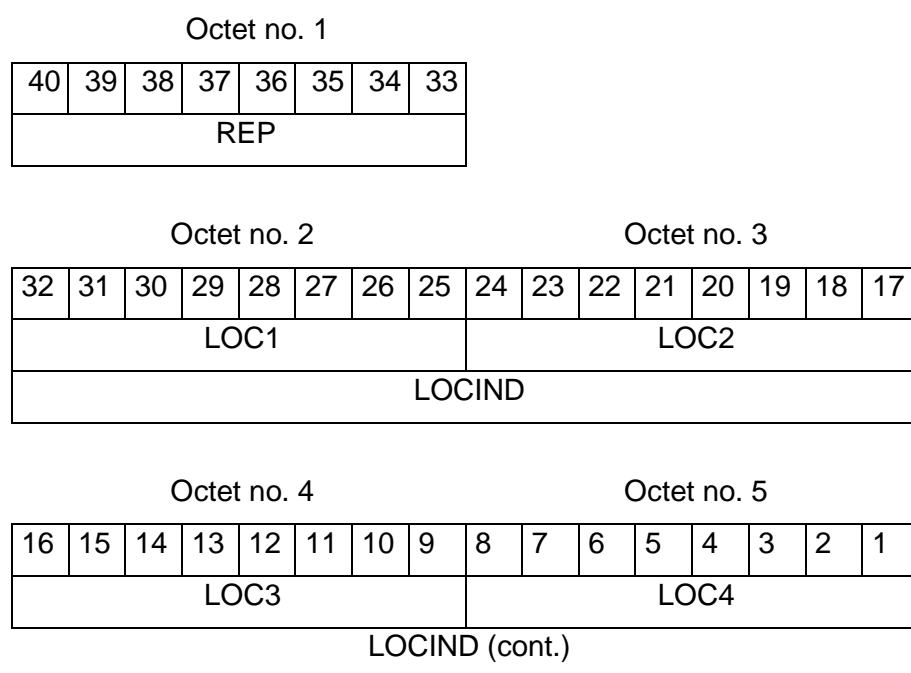

bits-40/33

(REP)

Number of Location Indicators

bits-32/1

(LOCIND)

Location Indicator as contained in Item A of the NOTAM consisting of the four ASCII Characters (A-Z) LOC1 – LOC4

**Encoding Rule:**

See Table 1 and Table 2

### 5.1.17 Data Item I237/140, Message Activation Time

**Definition:** Relative time at which the message comes into force, in seconds since January 1, 2020, 0:00.

**Format:** Four-octet fixed length Data Item.

**Structure:**

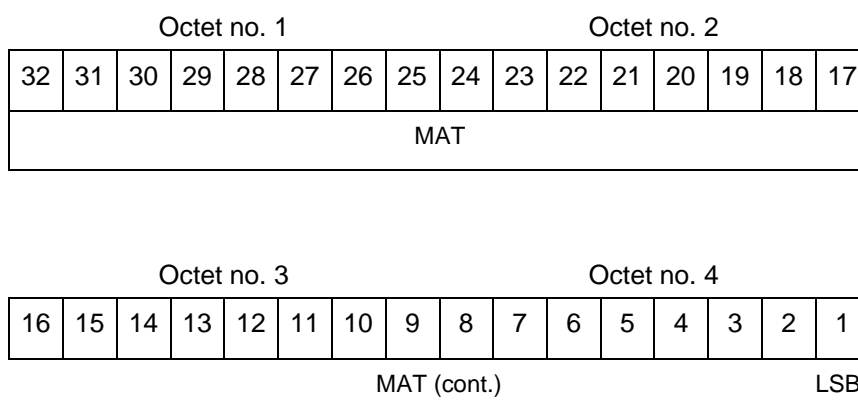

bits-32/1	(MAT)	Message activation time
bit-1	(LSB)	1 second

**Encoding Rule:**

See Table 1 and Table 2

- NOTE -** 1. For a NOTAM (Message Type = 001, 002 or 003), this represents ITEM B.
- NOTE -** 2. For a SNOWTAM (Message Type = 005 or 006), this represents the time of assessment.
- NOTE -** 3. For an ASHTAM (Message Type = 007 or 008), this represents the time of first eruption.

### 5.1.18 Data Item I237/150, Message Cancellation Time

**Definition:** Time when the message will be canceled. Seconds since January 1, 2020, 0:00.

**Format:** Five-octet fixed length Data Item.

**Structure:**

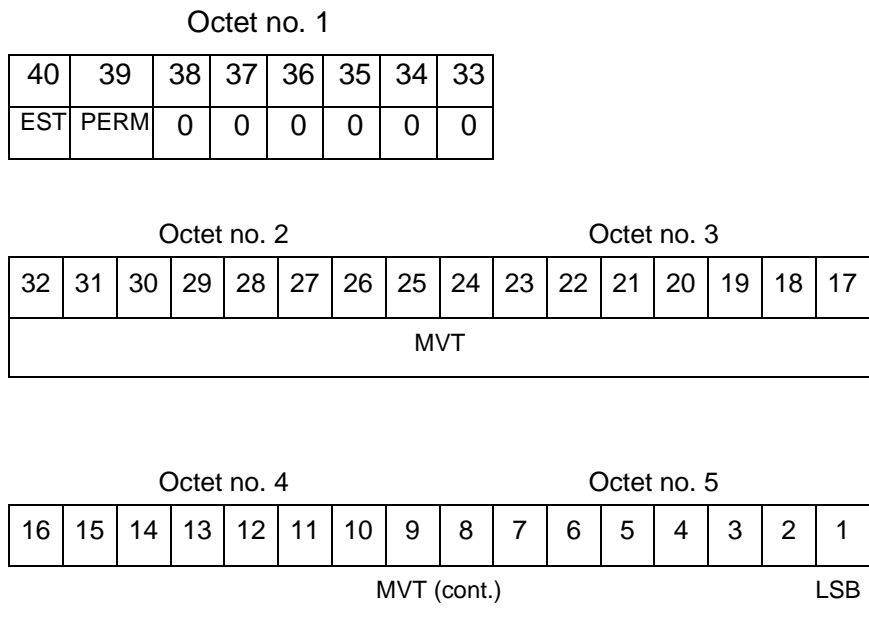

bit-40	(EST)	=0 Time is accurate =1 Time is estimated
bit-39	(PERM)	=0 Message has a defined end-time =1 Message is permanent, i. e. has no defined end-time
bits-38/33	(Spare)	Spare bits, set to 0
bits-32/1	(MVT)	Message validity time
bit-1	(LSB)	1 second

**Encoding Rule:**

See Table 1 and Table 2

**NOTE** - 1. If PERM is 1, MVT **shall** be set to 0.

**NOTE** - 2. For a NOTAM, this information is contained in Item C

**NOTE** - 3. For a BIRDTAM, this information is contained in Item B.

### 5.1.19 Data Item I237/160, Day/Time Schedule of actual Activity

**Definition:** Actual time of activity between “Message Activation Time” and “Message Cancellation Time”.

**Format:** Repetitive Data Item comprised of a one-octet Field Repetition Indicator (REP) followed by at least one octet containing characters.

**Structure:**

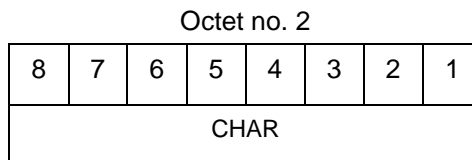
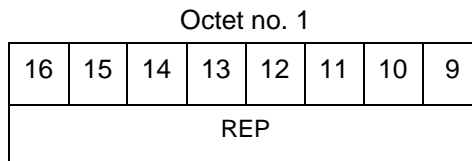

bits-16/9	(REP)	Number of characters describing the schedule
bits-8/1	(CHAR)	Day/Time Schedule as of NOTAM ITEM D with ASCII Character (0–9, A–Z, a–z, <SPACE>)

**Encoding Rule:**

See Table 1 and Table 2

This item **shall** only be sent when different from the period between “Message Activation Time” (I237/140) and “Message Cancellation Time” (I237/150)

**NOTE -** While “Message Activation Time” (I237/140) and “Message Cancellation Time” (I237/150) define the times during which the Message is in force, “Day/Time Schedule of actual Activity” (I237/160) defines the periods in which the activity described in the Message is actually taking place. For example, a Message could define a Danger Area to be active for a certain period (e. g. a week), but the actual activity could be limited to the daily period between sunrise and sunset.

**NOTE -** For further information or examples, see ICAO Doc. 1066 [2]

**NOTE -** Example: JUN 23 24 25 26 AND 27 1050 to 1800

### 5.1.20 Data Item I237/170, Free Text

**Definition:** Free Text.

**Format:** Repetitive Data Item comprised of a one-octet Field Repetition Indicator (REP) followed by at least one octet containing characters.

**Structure:**

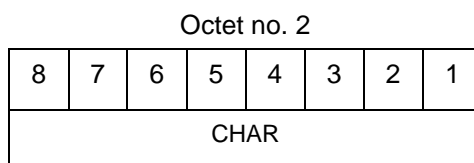
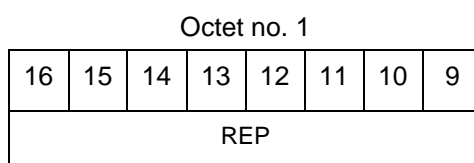

bits-16/9	(REP)	Number of characters in the Free Text
bits-8/1	(CHAR)	ASCII Character in Range 32–127

**Encoding Rule:**

See Table 1 and Table 2

- NOTE** - 1. For a NOTAM, this corresponds to Item E.
- NOTE** - 2. For a SNOWTAM, this corresponds to Item T.
- NOTE** - 3. For an ASHTAM, this corresponds to Item K.
- NOTE** - 4. For a BIRDTAM, this corresponds to ITEM H.

### 5.1.21 Data Item I237/180, Lower and Upper Limit

**Definition:** Lower and Upper Limit for navigation warnings.

**Format:** Five-octet fixed length Data Item.

**Structure:**

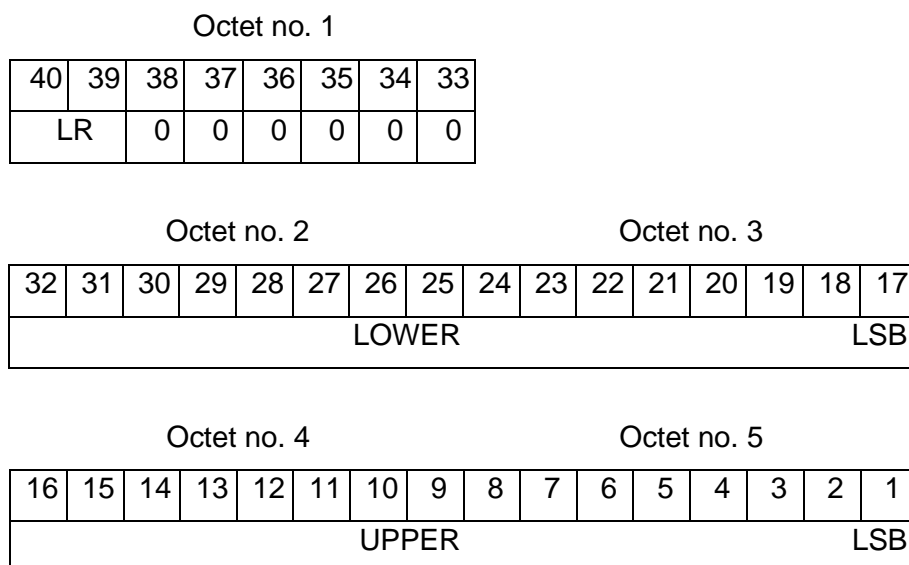

bits-40/39	(LR)	Limit reference =0 above ground/surface =1 above mean sea level =2 geometric height =3 QNH
bits-38/33	(Spare)	Spare bits, set to 0
bits-32/17	(LOWER)	Lower vertical limit of the activity
bit-32	(LOWER#EP)	Element Populated Bit (note 1) =0 Lower is not populated =1 Lower is populated
bits-31/17	(LOWER#VAL)	Lower vertical limit in two's complement
bit-17	(LSB)	25 ft



---

bits-16/1	(UPPER)	Upper limit of the activity
bit-16	(UPPER#EP)	Element Populated Bit (note 2) =0 Upper is not populated =1 Upper is populated
bits-31/17	(UPPER#VAL)	Upper vertical limit in two's complement
bit-1	(LSB)	25 ft

**Encoding Rule:**

See Table 1 and Table 2

- NOTE** - 1. If LOWER is not populated, the Lower Limit is unlimited.
- NOTE** - 2. If UPPER is not populated, the Upper Limit is unlimited.
- NOTE** - 3. For a NOTAM this corresponds to the Items QW and QR.
- NOTE** - 3. For an ASHTAM this item reports the vertical extension of the ash clouds as defined in ASHTAM Item F.
- NOTE** - 4. For a BIRDTAM, this corresponds to Item F and G.

### 5.1.22 Data Item I237/190, SNOWTAM: Runway Conditions

**Definition:** Runway conditions of the airport defined in Data Item I237/130.

**Format:** Repetitive Data Item comprised of a one-octet Field Repetition Indicator (REP) followed by at least one SNOWTAM runway report of fourteen octets.

**Structure:**

Octet 1															
120	119	118	117	116	115	114	113								
REP															
Octet 2							Octet 3								
112	111	110	109	108	107	106	105	104	103	102	101	100	99	98	97
RWY					RWYD		D1			D2					
Octet 4							Octet 5								
96	95	94	93	92	91	90	89	88	87	86	85	84	83	82	81
D3			G1				G2			G3					
Octet 6							Octet 7								
80	79	78	77	76	75	74	73	72	71	70	69	68	67	66	65
E1			E2				E3			F1					
Octet 8							Octet 9								
64	63	62	61	60	59	58	57	56	55	54	53	52	51	50	49
F1 (cont.)				F2						F3					
Octet 10							Octet 11								
48	47	46	45	44	43	42	41	40	39	38	37	36	35	34	33
F3 (cont.)				H						I					
Octet 12							Octet 13								
32	31	30	29	28	27	26	25	24	23	22	21	20	19	18	17
I (cont.)											J	K	L	M	
Octet 14							Octet 15								
16	15	14	13	12	11	10	9	8	7	6	5	4	3	2	1
O	S						0	0	0	0	0	0	0	0	0

---

bits-120/113	(REP)	Number of runway condition reports
SNOWTAM Item C:		
bits-112/107	(RWY)	Runway direction (1–36)
bits-106/105	(RWYD)	Runway designator =0 not defined (single RWY / all RWY) =1 left =2 right =3 centre
SNOWTAM Item D:		
bits-104/101	(D1)	Runway condition code 1 <sup>st</sup> third
bit-104	(D1#EP)	Element Populated Bit (note 1) =0 D1 not populated =1 D1 populated
bits-103/101	(D1#VAL)	Runway condition code value 1 <sup>st</sup> third (0–6) (note 2)
bits-100/97	(D2)	Runway condition code 2 <sup>nd</sup> third
bit-100	(D2#EP)	Element Populated Bit (note 1) =0 D2 not populated =1 D2 populated
bits-99/97	(D2#VAL)	Runway condition code value 2 <sup>nd</sup> third (0–6) (note 2)
bits-96/93	(D3)	Runway condition code 3 <sup>rd</sup> third
bit-96	(D3#EP)	Element Populated Bit (note 1) =0 D3 not populated =1 D3 populated
bits-95/93	(D3#VAL)	Runway condition code value 3 <sup>rd</sup> third (0–6) (note 2)
SNOWTAM Item G:		
bits-92/89	(G1)	Runway condition 1 <sup>st</sup> runway third Code (see Table 3 below)
bits-88/85	(G2)	Runway condition 2 <sup>nd</sup> runway third Code (see Table 3 below)
bits-84/81	(G3)	Runway condition 3 <sup>rd</sup> runway third Code (see Table 3 below)

---

## SNOWTAM Item E:

bits-80/77	(E1)	Coverage 1 <sup>st</sup> runway third
bit-80	(E1#EP)	Element Populated Bit
		=0 E1 not populated
		=1 E1 populated
bits-79/77	(E1#VAL)	Coverage 1 <sup>st</sup> runway third value
		=0 ≤ 25%
		=1 ≤ 50%
		=2 ≤ 75%
		=3 ≤ 100%
bits-76/73	(E2)	Coverage 2 <sup>nd</sup> runway third
bit-76	(E2#EP)	Element Populated Bit
		=0 E2 not populated
		=1 E2 populated
bits-75/73	(E2#VAL)	Coverage 2 <sup>nd</sup> runway third value
		=0 ≤ 25%
		=1 ≤ 50%
		=2 ≤ 75%
		=3 ≤ 100%
bits-72/69	(E3)	Coverage 3 <sup>rd</sup> runway third
bit-72	(E3#EP)	Element Populated Bit
		=0 E3 not populated
		=1 E3 populated
bits-71/69	(E3#VAL)	Coverage 3 <sup>rd</sup> runway third value
		=0 ≤ 25%
		=1 ≤ 50%
		=2 ≤ 75%
		=3 ≤ 100%

## SNOWTAM Item F:

bits-68/61	(F1)	Depth of loose contaminant 1 <sup>st</sup> runway third
bit-68	(F1#EP)	Element Populated Bit =0 F1 not populated =1 F1 populated
bits-67/61	(F1#VAL)	Depth of loose contaminant 1 <sup>st</sup> runway third value (note 3)
bit-61	(LSB)	1 mm
bits-60/53	(F2)	Depth of loose contaminant 2 <sup>nd</sup> runway third
bit-60	(F2#EP)	Element Populated Bit =0 F2 not populated =1 F2 populated
bits-59/53	(F2#VAL)	Depth of loose contaminant 2 <sup>nd</sup> runway third value (note 3)
bit-53	(LSB)	1 mm
bits-52/45	(F3)	Depth of loose contaminant 3 <sup>rd</sup> runway third
bit-52	(F3#EP)	Element Populated Bit =0 F3 not populated =1 F3 populated
bits-51/45	(F3#VAL)	Depth of loose contaminant 3 <sup>rd</sup> runway third value (note 3)
bit-45	(LSB)	1 mm

## SNOWTAM Item H:

bits-44/37	(H)	Runway width to which the runway condition codes apply
bit-44	(H#EP)	Element Populated Bit =0 H not populated =1 H populated
bits-43/37	(H#VAL)	Runway width to which the runway condition codes apply
bit-37	(LSB)	1 m

---

SNOWTAM Item I:		
bits-36/21	(I)	Reduced runway length
bit-36	(I#EP)	Element Populated Bit
		=0 I not populated
		=1 I populated
bits-35/21	(I#VAL)	Runway length
bit-21	(LSB)	1 m
SNOWTAM Item J:		
bit-20	(J)	Drifting snow on reported runway
		=0 No
		=1 Yes
SNOWTAM Item K:		
bit-19	(K)	Loose sand on reported runway
		=0 No
		=1 Yes
SNOWTAM Item L:		
bit-18	(L)	Chemical treatment on reported runway
		=0 No
		=1 Yes
SNOWTAM Item M:		
bit-17	(M)	Snow banks on reported runway
		=0 No
		=1 Yes
SNOWTAM Item O:		
bit-16	(O)	Snow banks adjacent to reported runway
		=0 No
		=1 Yes
SNOWTAM Item S:		
bits-15/8	(S)	measured Friction Coefficient
bit-15	(S#EP)	Element Populated Bit
		=0 S not populated
		=1 S populated
bits-14/8	(S#VAL)	measured Friction Coefficient [0–1]
bit-8	(LSB)	= 0.01
bits-7/1	(spare)	Spare bits, set to 0

---

**Encoding Rule:**

See Table 1 and Table 2

**NOTE** - 1. If D2/D3 are not populated, D1 is for the whole runway.**NOTE** - 2. The condition values can range from 0 as worst to 6 as best condition.**NOTE** - 3. If the value of 255 is used, this is to be interpreted as 255 or higher.**NOTE** - 4. The friction measurement method is encoded in Data Item I237/195.**Table 3:**

Condition description over total runway length	Code
COMPACTED SNOW	0
DRY	1
DRY SNOW	2
DRY SNOW ON TOP OF COMPACTED SNOW	3
DRY SNOW ON TOP OF ICE	4
FROST	5
ICE	6
SLUSH	7
STANDING WATER	8
WATER ON TOP OF COMPACTED SNOW	9
WET	10
WET ICE	11
WET SNOW	12
WET SNOW ON TOP OF COMPACTED SNOW	13
WET SNOW ON TOP OF ICE	14
(RESERVED FOR FUTURE USE)	15

### 5.1.23 Data Item I237/195, SNOWTAM: Friction Measurement Method

**Definition:** This item contains free text to specify the friction measurement method used to determine the runway friction coefficient.

**Format:** Repetitive Data Item starting with a one-octet Field Repetition Indicator (REP) followed by a plain text field of Characters.

**Structure:**

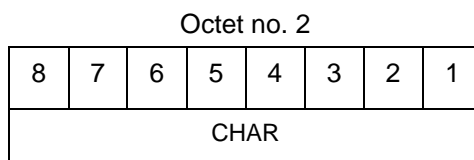
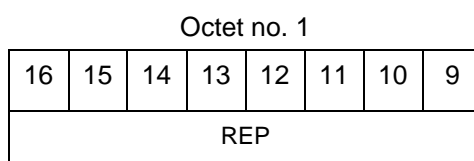

bits-16/9	(REP)	Number of characters describing the measurement method
bits-8/1	(CHAR)	ASCII Character in range 32–127

**Encoding Rule:**  
See Table 1 and Table 2





### 5.1.25 Data Item I237/210, SNOWTAM: Apron Conditions

**Definition:** Conditions of the Aprons of the airport.

**Format:** Repetitive Data Item starting with a one-octet Field Repetition Indicator (REP) followed by at least one five-octet Apron report.

**Structure:**

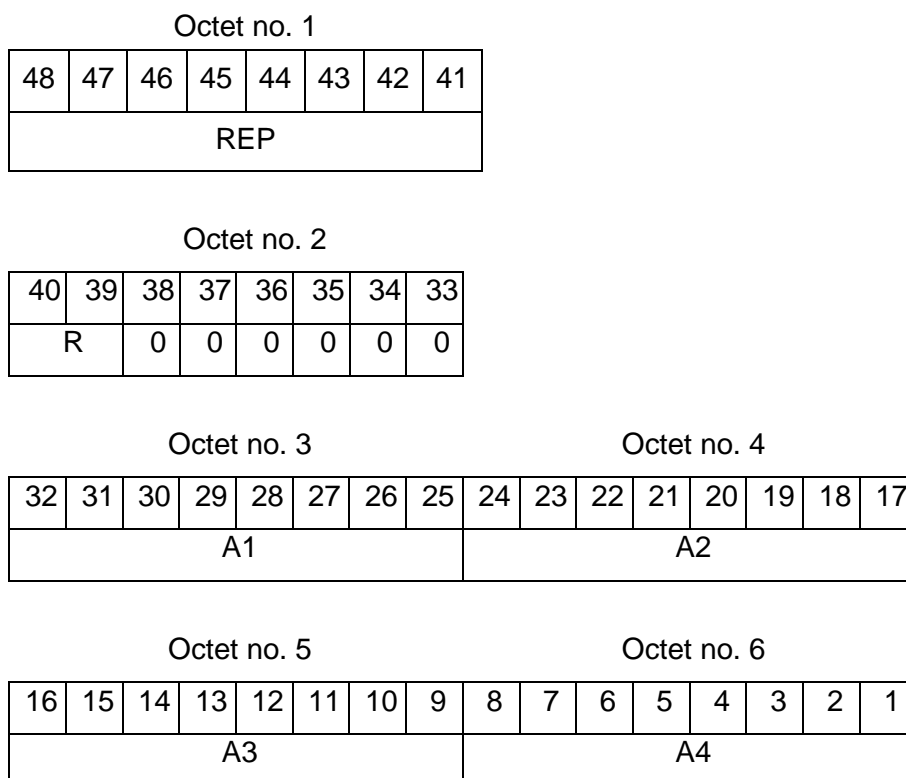

bits-48/41 (REP) Number of Apron reports

SNOWTAM Item R:

bits-40/39	(R)	Apron conditions
bit-40	(R#EP)	Element Populated Bit
		= 0 R not populated
		= 1 R populated
bit-39	(R#VAL)	= 0 Poor conditions on reported Apron
		= 1 Poor conditions on all Aprons
bits-38/33	(spare)	Spare bits, set to 0
bits-32/25	(A1)	First number designating the Apron
bit-32	(A1#EP)	Element Populated Bit

		= 0 A1 not populated = 1 A1 populated
bits-31/25	(A1#VAL)	First number designating the Apron in ASCII Characters (A–Z, 0–9, a–z)
bits-24/17	(A2)	Second number designating the Apron
bit-24	(A2#EP)	Element Populated Bit = 0 A2 not populated = 1 A2 populated
bits-23/17	(A2#VAL)	Second number designating the Apron in ASCII Characters (A–Z, 0–9, a–z)
bits-16/9	(A3)	Third number designating the Apron
bit-16	(A3#EP)	Element Populated Bit = 0 A3 not populated = 1 A3 populated
bits-15/9	(A3#VAL)	Third number designating the Apron in ASCII Characters (A–Z, 0–9, a–z)
bits-8/1	(A4)	Fourth number designating the Apron
bit-8	(A4#EP)	Element Populated Bit = 0 A4 not populated = 1 A4 populated
bits-7/1	(A4#VAL)	Fourth number designating the Apron in ASCII Characters (A–Z, 0–9, a–z)

**Encoding Rule:**

See Table 1 and Table 2

**NOTE** - If R#VAL is set to 1, there is only one REP. In this case A1#EP, A2#EP, A3#EP, and A4#EP **shall** be set to '0'.

### 5.1.26 Data Item I237/220, ASHTAM

**Definition:** The ASHTAM provides information on the status of activity of a volcano when a change in its activity is, or is expected to be, of operational significance.

**Format:** Compound Data Item, comprising a primary subitem of up to two octets, followed by the indicated subfields.

**Structure of Primary Subitem:**

Octet no. 2							Octet no. 1								
16	15	14	13	12	11	10	9	8	7	6	5	4	3	2	1
A	C1	C2	D1	D2	D3	E	FX	F	G	H	I	J	0	0	FX

ASHTAM Item A:

bit-16 (A) FIR affected  
 =0 Subitem #1 not present  
 =1 Subitem #1 present

ASHTAM Item C:

bit-15 (C1) Name of volcano  
 =0 Subitem #2 not present  
 =1 Subitem #2 present

bit-14 (C2) Number of volcano  
 =0 Subitem #3 not present  
 =1 Subitem #3 present

ASHTAM Item D:

bit-13 (D1) Position of volcano  
 =0 Subitem #4 not present  
 =1 Subitem #4 present

bit-12 (D2) Name of Navaid  
 =0 Subitem #5 not present  
 =1 Subitem #5 present

bit-11 (D3) Direction/distance from Navaid  
 =0 Subitem #6 not present  
 =1 Subitem #6 present

---

ASHTAM Item E:		
bit-10	(E)	Alert level =0 Subitem #7 not present =1 Subitem #7 present
bit-9	(FX)	Field extension indicator =0 End of data item =1 Extension into first Extension
ASHTAM Item F:		
bit-8	(F)	Horizontal extension ash cloud =0 Subitem #8 not present =1 Subitem #8 present
ASHTAM Item G:		
bit-7	(G)	Forecast ash cloud movement =0 Subitem #9 not present =1 Subitem #9 present
ASHTAM Item H:		
bit-6	(H)	Affected airways and altitudes =0 Subitem #10 not present =1 Subitem #10 present
ASHTAM Item I:		
bit-5	(I)	Closure of airways/airspace =0 Subitem #11 not present =1 Subitem #11 present
ASHTAM Item J:		
bit-4	(J)	Information source =0 Subitem #12 not present =1 Subitem #12 present
bits-3/2	(Spare)	Spare bits, set to 0
bit-1	(FX)	Field extension indicator =0 End of data item =1 Extension into second Extension

**Encoding Rule:**  
See Table 1 and Table 2

**NOTE** - Example: **A)** SAVF **B)** 02061557 **C)** CHAITEN 1508-41 **D)** 4250S/07239W  
**E)** NIL **F)** VA CLD OBS AT 1400Z TOP FL070 **G)** MOV NE EXTD 65 KM  
20KT **H)** 06/2000Z SFC/FL200 W44 TORES/ESQUEL, L775 **I)** NIL **J)** VA  
ADVISORY CENTRE BUENOS AIRES **K)** FCST ASH CLD + 06HR:  
06/2000Z SFC/FL200 S4145 W07145 - S4150 W07130 - S4300W07230 -  
S4230 W07245 - S4145 W07145 FL200/350 NO ASH EXP FL350/550 NO  
ASH EXP FCST ASH CLD + 12HR: 07/0200Z SFC/FL200 S4130 W07210 -  
S4130 W07145 - S4300 W07230 - S4230 W07245 - S4130 W07210  
FL200/350 NO ASH EXPFL350/550 NO ASH EXP FCST ASH CLD +  
18HR: 07/0800Z SFC/FL200 S4100 W07230 - S4100 W07200 -  
S4230W07215 - S4300 W07300 - S4100 W07230 FL200/350 NO ASH  
EXP FL350/550 NO ASH NEXT ADVISORY: FURTHER INFORMATION  
WILL BE ISSUED IF ANY ASH CLD IS DETECTED/OBSERVED

**Structure of Subitem #1 of Data Item I237/220: FIR Affected (Item A)**

Octet no. 1

16	15	14	13	12	11	10	9
REP							

Octet no. 2

8	7	6	5	4	3	2	1
CHAR							

bits-16/9	(REP)	Number of characters describing the region.
bits-8/1	(CHAR)	Plain language equivalent of the location indicator of the FIR in ASCII Characters (A–Z, 0–9, a–z)

**Structure of Subitem #2 of Data Item I237/220: Name of volcano (Item C)**

Octet no. 1

16	15	14	13	12	11	10	9
REP							

Octet no. 2

8	7	6	5	4	3	2	1
CHAR							

bits-16/9	(REP)	Number of characters of the volcano name
bits-8/1	(CHAR)	Name of volcano as ASCII Character in range 32–127.

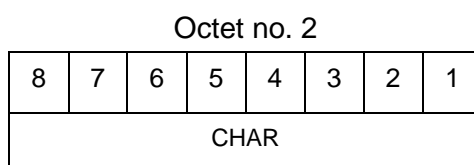
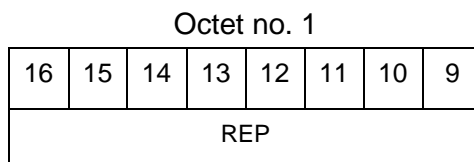
**Structure of Subitem #3 of Data Item I237/220: Number of Volcano (Item C)**

bits-16/9	(REP)	Number of characters containing the number of the volcano
bits-8/1	(CHAR)	Number of the volcano as ASCII Character in range 32–127

**NOTE** - For further information see ICAO Doc 9691 AN/954 [11]

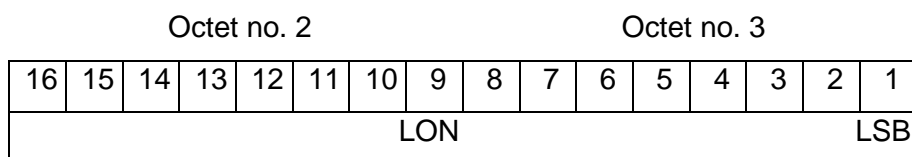
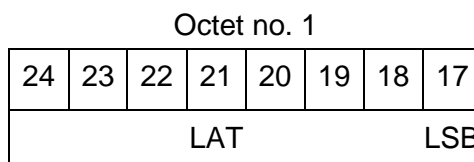
**Structure of Subitem #4 of Data Item I237/220: Position of volcano (Item D)**

bits-24/17	(LAT)	Latitude in WGS.84 in two's complement. [-90°, 90°] (note 1)
bit-17	(LSB)	1 degree
bits-16/1	(LON)	Longitude in WGS.84 in two's complement. [-180°, 179°] (note 2)
bit-1	(LSB)	1 degree

**NOTE** - 1. Negative values represent South, positive values represent North

**NOTE** - 2. Negative values represent West, positive values represent East.



**Structure of Subitem #5 of Data Item I237/220: Name of Navaid (Item D)**

Octet no. 1

16	15	14	13	12	11	10	9
REP							

Octet no. 2

8	7	6	5	4	3	2	1
CHAR							

bits-16/9	(REP)	Number of characters of the Navaid name
bits-8/1	(CHAR)	Name of Navaid as ASCII Character in range 32–127.

**Structure of Subitem #6 of Data Item I237/220: Distance and Direction from Navaid (Item D)**

Octet no. 1

Octet no. 2

32	31	30	29	28	27	26	25	24	23	22	21	20	19	18	17
RHO														LSB	

Octet no. 3

Octet no. 4

16	15	14	13	12	11	10	9	8	7	6	5	4	3	2	1
THETA														LSB	

bits-32/17	(RHO)	Radial distance of the volcano (0 NM, 999 NM)
bit-17	(LSB)	1 NM
bits-16/1	(THETA)	Direction from Navaid to volcano (0°, 359°)
bit-1	(LSB)	1 degree

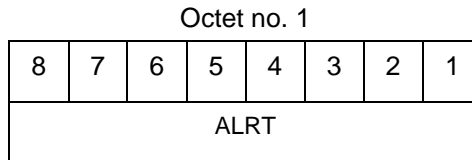
**Structure of Subitem #7 of Data Item I237/220: Alert Level (Item E)**

bits-8/1

(ALRT)

Colour code for alert level

= 0 invalid ASTERIX value

= 1 green alert

= 2 yellow alert

= 3 orange alert

= 4 red alert

= 5 ... 255 reserved for future use

**Structure of Subitem #8 of Data Item I237/220: Horizontal Extension Ash Cloud (Item F)**

Octet no. 1

32	31	30	29	28	27	26	25
REP						LSB	

Octet no. 2

24	23	22	21	20	19	18	17
LAT						LSB	

Octet no. 3

Octet no. 4

16	15	14	13	12	11	10	9	8	7	6	5	4	3	2	1
LON														LSB	

bits-32/25	(REP)	Number of corners of the polygon representing the ash cloud
bits-24/17	(LAT)	Latitude in WGS.84 in two's complement. [-90°, 90°] (note 1)
bit-17	(LSB)	1 degree
bits-16/1	(LON)	Longitude in WGS.84 in two's complement. [-180°, 179°] (note 2)
bit-1	(LSB)	1 degree

**NOTE -** 1. Negative values represent South, positive values represent North

**NOTE -** 2. Negative values represent West, positive values represent East.

**Structure of Subitem #9 of Data Item I237/220: Forecast Ash Cloud Movement (Item G)**

Octet no. 1								Octet no. 2							
16	15	14	13	12	11	10	9	8	7	6	5	4	3	2	1
N	E	S	W	VEL							LSB				

bit-16	(N)	=0 Ash cloud is not moving north =1 Ash cloud is moving north
bit-16	(E)	=0 Ash cloud is not moving east =1 Ash cloud is moving east
bit-16	(S)	=0 Ash cloud is not moving south =1 Ash cloud is moving south
bit-16	(W)	=0 Ash cloud is not moving west =1 Ash cloud is moving west
bits-12/1:	(VEL)	Velocity of the ash cloud
bit-1	(LSB)	1 kn

**NOTE -** For bits 16/13 combinations are allowed (e. g. NW for northwest)

**Structure of Subitem #10 of Data Item I237/220: Affected Airways and Altitudes (Item H)**

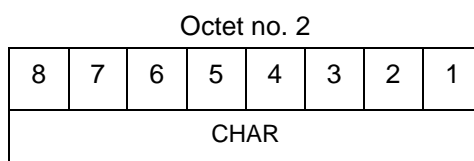
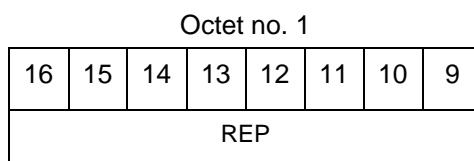

bits-16/9            (REP)            Number of characters describing the affected airways and altitudes.

bits-8/1            (CHAR)            Air routes or parts of air routes and flight levels affected or expected to become affected in ASCII Characters in range 32–127.

**Structure of Subitem #11 of Data Item I237/220: Closure of Airways/Airspace (Item I)**

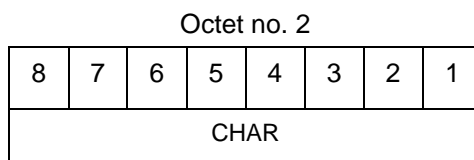
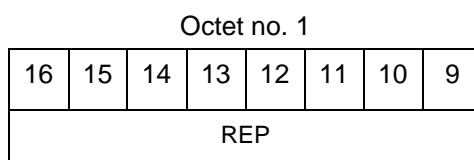

bits-16/9            (REP)            Number of characters describing the closure of airways/airspace

bits-8/1            (CHAR)            Air routes or parts of air routes or airspace closed and availability of alternative routes in ASCII Characters (A–Z, 0–9, a–z)

**Structure of Subitem #12 of Data Item I237/220: Information Source (Item J)**

Octet no. 1

16	15	14	13	12	11	10	9
REP							

Octet no. 2

8	7	6	5	4	3	2	1
CHAR							

bits-16/9	(REP)	Number of characters describing the Information Source.
bits-8/1	(CHAR)	Name of the source of the information (e. g. "special air-report" or "vulcanological agency") in ASCII Characters (A–Z, a-z, 0-9, <SPACE>)

### 5.1.27 Data Item I237/230, BIRDTAM

**Definition:** Birdstrike risk levels in defined areas.

**Format:** Repetitive Data Item starting with a one-octet Field Repetition Indicator (REP) followed by at least one seven-octet Birdstrike Intensity Report.

**Structure:**

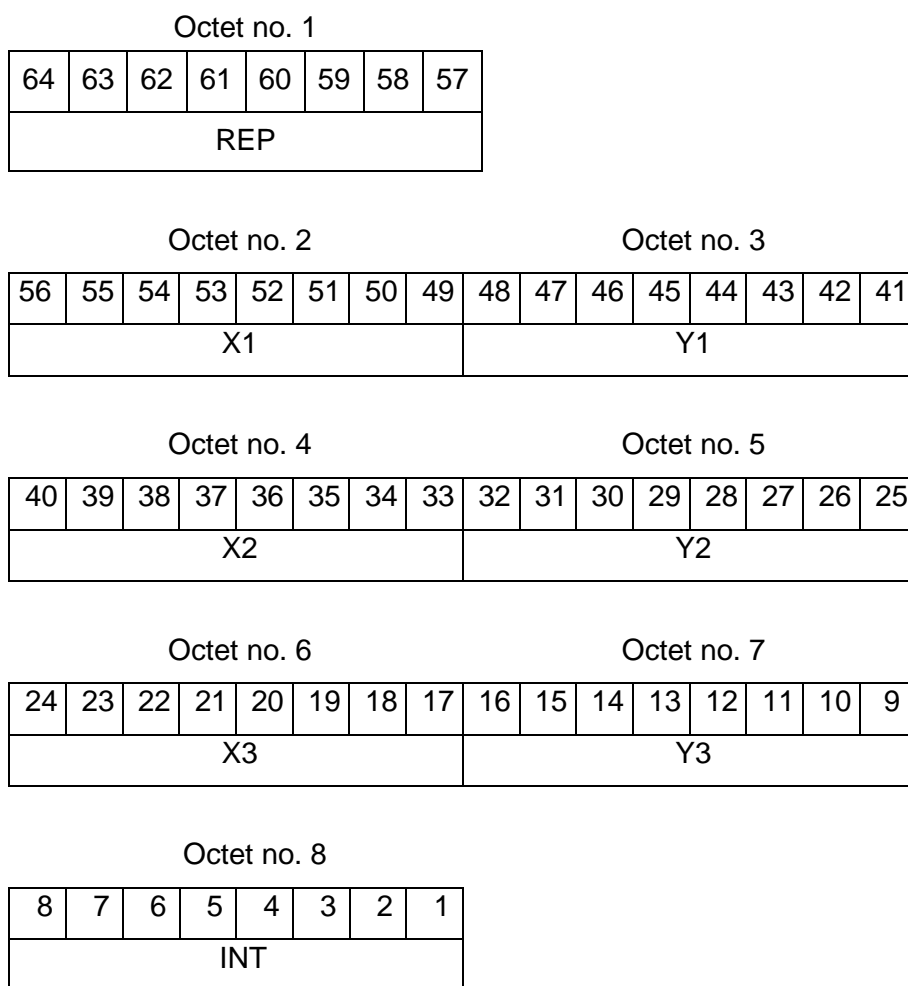

bits-64/57 (REP) Number of areas with Birdstrike risk.

bits-56/49 (X1) ASCII Character (A–Z, 0–9) for X1-coordinate of first zone

bits-48/41 (Y1) ASCII Character (A–Z, 0–9) for Y1-coordinate of first zone

bits-40/33	(X2)	ASCII Character (A–Z, 0–9) for X2-coordinate of second zone
bits-32/25	(Y2)	ASCII Character (A–Z, 0–9) for Y2-coordinate of second zone
bits-24/17	(X3)	ASCII Character (A–Z, 0–9) for X3-coordinate of third zone
bits-16/9	(Y3)	ASCII Character (A–Z, 0–9) for Y3-coordinate of third zone
bits-8/1	(INT)	Bird Intensity (0...8)

**Encoding Rule:**

See Table 1 and Table 2

**NOTE** - This Data Item represents Items D and E of a BIRDTAM.

**NOTE** - The characters refer to the GEOREF / UTM zones. The coordinate system which has been used, shall be specified in the ICD of the system.

**NOTE** - If more zones are used, the zone on the map will be smaller and more specific. If a Zone is not used, it shall be set to 255.

**NOTE** - Example: NK KF (see <https://www.davvl.de/unsere-leistungen/birdtam>)



### 5.1.28 Data Item I237/240, METAR / SPECI

**Definition:** METAR / SPECI report on locally observed weather conditions at a given aerodrome.

**Format:** Compound Data Item, comprising a primary subitem of up to three octets, followed by the indicated subfields.

**Structure of Primary Subitem:**

Octet no. 1

24	23	22	21	20	19	18	17
ATT	SWC	SDV	SSV	VIS	LVS	RVR	FX

Octet no. 2

16	15	14	13	12	11	10	9
PW	CLD	TMP	QNH	REW	WSH	SLP	FX

Octet no. 3

8	7	6	5	4	3	2	1
RWY	PV	0	0	0	0	0	FX

bit-24	(ATT)	Automated or Missing Report =0 Subitem #1 not present =1 Subitem #1 present
bit-23	(SWC)	Surface wind conditions =0 Subitem #2 not present =1 Subitem #2 present
bit-22	(SDV)	Significant directional wind variations =0 Subitem #3 not present =1 Subitem #3 present
bit-21	(SSV)	Significant windspeed variations =0 Subitem #4 not present =1 Subitem #4 present
bit-20	(VIS)	Visibility =0 Subitem #5 not present =1 Subitem #5 present

---

bit-19	(LVS)	Lowest visibility =0 Subitem #6 not present =1 Subitem #6 present
bit-18	(RVR)	Runway visual range =0 Subitem #7 not present =1 Subitem #7 present
bit-17	(FX)	Field extension indicator =0 End of primary subitem =1 Extension into second octet
bit-16	(PW)	Present weather =0 Subitem #8 not present =1 Subitem #8 present
bit-15	(CLD)	Clouds =0 Subitem #9 not present =1 Subitem #9 present
bit-14	(TMP)	Air temperature / dew point =0 Subitem #10 not present =1 Subitem #10 present
bit-13	(QNH)	Atmospheric pressure =0 Subitem #11 not present =1 Subitem #11 present
bit-12	(REW)	Recent weather =0 Subitem #12 not present =1 Subitem #12 present
bit-11	(WSH)	Wind shear =0 Subitem #13 not present =1 Subitem #13 present
bit-10	(SLP)	Sea level pressure

---

			=0 Subitem #14 not present =1 Subitem #14 present
bit-9	(FX)	Field Extension Indicator	=0 End of secondary subitem =1 Extension into third octet
bit-8	(RWY)	State of runway	=0 Subitem #15 not present =1 Subitem #15 present
bit-7	(PV)	Prevision	=0 Subitem #16 not present =1 Subitem #16 present
bits-6/2	(Spare)	Spare bits, set to 0	
bit-1	(FX)	Field extension indicator	=0 End of primary subitem =1 Extension into next octet

**Encoding Rule:**

See Table 1 and Table 2

**NOTE** - For examples and definitions see ICAO Doc. 8896 [4] and METAR explanation [12]

**Structure of Subitem #1 of Data Item I237/240: Manual, Automated or Missing Report**

Octet no. 1

8	7	6	5	4	3	2	1
REP		0	0	0	0	0	0

bits-8/7

(REP)

=0 Manual Report

=1 Report from an automated observation system, METAR present  
=2 Report from an automated observation system, METAR missing (NIL).

=3 Reserved for future use

**Structure of Subitem #2 of Data Item I237/240: Surface Wind Conditions**

Octet no. 2								Octet no. 1									
16	15	14	13	12	11	10	9	8	7	6	5	4	3	2	1		
DIR								LSB	VRB	WS							LSB

bits-16/9	(DIR)	Wind direction
bit-16	(DIR#EP)	Element Populated Bit = 0 DIR not populated = 1 DIR populated
bits-15/9	(DIR#VAL)	Wind direction (10°...360°) (note 1)
bit-9	(LSB)	10°
bit-8	(VRB)	=0 Stable wind direction (note 2) =1 Variable winds
bits-7/1	(WS)	Windspeed (0...127 kn) (note 3)
bit-1	(LSB)	1 kn

**NOTE -** 1. The direction 360° means North, 90° means East, 180° means South and 270° means West.

**NOTE -** 2. If VRB = 1, DIR#EP **shall** be set to 0.

**NOTE -** 3. If WS > 127 kn, it should be set to 127 kn.

### Structure of Subitem #3 of Data Item I237/240: Significant Directional Wind Variations

Octet no. 1								Octet no. 2								
16	15	14	13	12	11	10	9	8	7	6	5	4	3	2	1	
DIR1								LSB	DIR2							LSB

bits-16/9	(DIR1)	First extreme direction from which variable surface wind is blowing (10°... 360°)
bit-9	(LSB)	10°
bits-8/1	(DIR2)	Second extreme direction from which variable surface wind is blowing (10°... 360°)
bit-1	(LSB)	10°

**NOTE** - If VRB in Subitem #2 is set, then there should be no Subitem #3, because VRB means no significant wind direction.

### Structure of Subitem #4 of Data Item I237/240: Significant Windspeed Variations

Octet no. 1							
8	7	6	5	4	3	2	1
WS							LSB

bits-8/1	(WS)	Maximum Windspeed
bit-1	(LSB)	1 kn

**NOTE** - If WS  $\geq$  255 kn, it should be set to 255.

**NOTE** - If there are gusts, this Subitem represents the maximum windspeed of a gust.

**Structure of Subitem #5 of Data Item I237/240: Visibility**

Octet no. 1									Octet no. 2										
16	15	14	13	12	11	10	9	8	7	6	5	4	3	2	1				
VIS									LSB			CD				0	0	0	0

bits-16/9	(VIS)	Maximum visibility
bit-9	(LSB)	50 metres
bits-8/5	(CD)	Compass direction
		=0 no specific direction
		=1 North
		=2 Northeast
		=3 East
		=4 Southeast
		=5 South
		=6 Southwest
		=7 West
		=8 Northwest
bits-4/1	(Spare)	Spare bits, set to 0

**NOTE** - Visibility  $\geq$  12,5 km shall be encoded as 12500 metres.

**NOTE** - Visibility < 50 metres shall be encoded as 0 metres.

**NOTE** - Visibility is relative to the aerodrome reference point.

**Structure of Subitem #6 of Data Item I237/240: Lowest Visibility**

Octet no. 1								Octet no. 2								
16	15	14	13	12	11	10	9	8	7	6	5	4	3	2	1	
LVIS								LSB	CD				0	0	0	0

bits-16/9	(LVIS)	Lowest visibility
bit-9	(LSB)	50 metres
bits-8/5	(CD)	Compass direction
		=0 no specific direction
		=1 North
		=2 Northeast
		=3 East
		=4 Southeast
		=5 South
		=6 Southwest
		=7 West
		=8 Northwest
bits-4/1	(Spare)	Spare bits, set to 0

**NOTE** - Visibility  $\geq$  12,5 km shall be encoded as 12500 metres.

**NOTE** - Visibility < 50 metres shall be encoded as 0 metres.

**NOTE** - Visibility is relative to the aerodrome reference point.



**Structure of Subitem #7 of Data Item I237/240: Runway visual range**

Octet no. 1							
32	31	30	29	28	27	26	25
REP							

Octet no. 1								Octet no. 2							
24	23	22	21	20	19	18	17	16	15	14	13	12	11	10	9
RWN						RWD	RVR						LSB		

Octet no. 1							
8	7	6	5	4	3	2	1
UDN	RVE	0	0	0	0	0	0

bits-32/25	(REP)	Number of reported runways
bits-24/19	(RWN)	Runway number (1...36)
bits-18/17	(RWD)	Runway designator =0 not available (e. g. for single runway) =1 Left =2 Right =3 Centre
bits-16/9	(RVR)	Runway visual range (0 m...2000 m) (note 2 and note 3)
bit-9	(LSB)	25 metres
bits-8/7	(UDN)	Tendency =0 No indication =1 Upward tendency =2 Downward tendency =3 No distinct tendency
bit-6	(RVE)	Runway visual range exceeded (≥ 2000 m) =0 Runway visual range not exceeded =1 Runway visual range exceeded
bits-5/1	(Spare)	Spare bit, set to 0

- NOTE** - 1. If there is a variable visual range, there should be a second repetition of the runway with the same RWN and RWD.
- NOTE** - 2. Visual range  $\geq$  2000 m shall be encoded as 2000 m and RVE **shall** be set to 1.
- NOTE** - 3. Visual range  $<$  25 m shall be encoded as 0 m.

**Structure of Subitem #8 of Data Item I237/240: Present Weather**

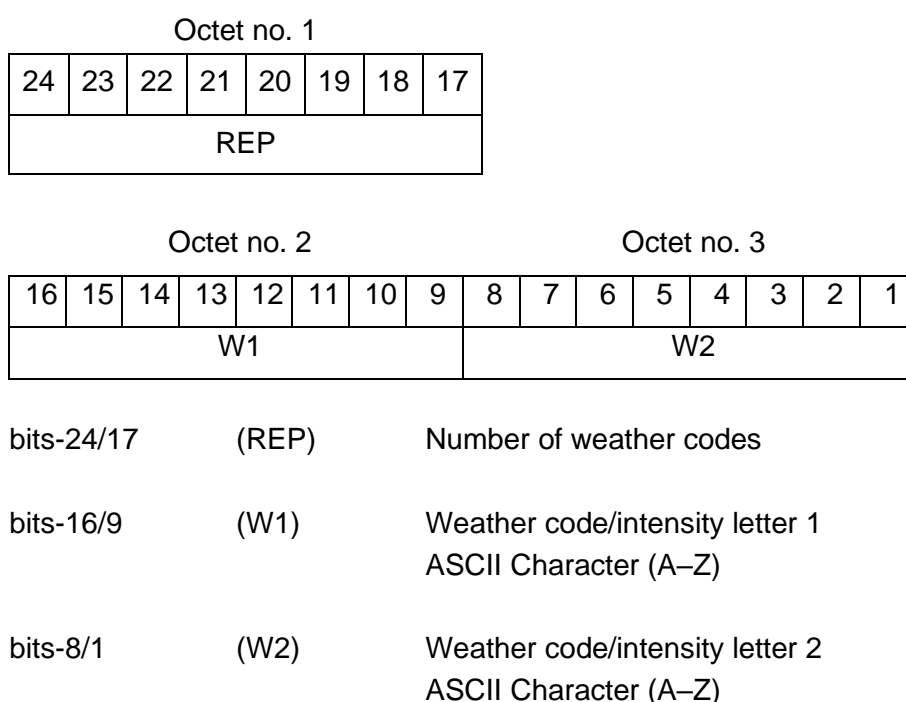

- NOTE** - Types, characteristics, intensity and proximity of present weather are encoded in weather code letters. The codes for weather intensity are LI (light) and HE (heavy)
- NOTE** - The weather codes can be found in the ICAO Doc. 8896 [4]
- NOTE** - Example: FG means Fog

**Structure of Subitem #9 of Data Item I237/240: Cloud**

Octet no. 1								Octet no. 2								Octet no. 3								
24	23	22	21	20	19	18	17	16	15	14	13	12	11	10	9	8	7	6	5	4	3	2	1	
REP								VV				CT		0	0	HCB								LSB

bits-24/17	(REP)	Number of cloud type reports
bits-16/13	(VV)	Vertical visibility =0 No indication =1 No cloud detected (NCD) =2 Sky clear (SKC) =3 Sky clear from automated station (CLR) =4 No significant cloud (NSC) =5 Clouds and visibility OK (CAVOK) =6 FEW (1–2 octas) =7 SCT (3–4 octas) =8 BKN (5–7 octas) =9 OVC (8 octas) =10 Lack of cloud data =11-14 Reserved for future use =15 Vertical visibility report (see Note)
bits-12/11	(CT)	Cloud type =0 No indication =1 Cumulonimbus (CB) =2 Towering cumulus (TCU) =3 Lack of cloud data
bits-10/9	(Spare)	Spare bits, set to 0

bits-8/1	(HCB)	Height of cloud base
bit-1	(LSB)	100 ft

**NOTE** - If VV is set to "15", CT should be set to "0" and HCB should be used for the vertical visibility.

**Structure of Subitem #10 of Data Item I237/240: Temperature and dew point**

Octet no. 1								Octet no. 2							
16	15	14	13	12	11	10	9	8	7	6	5	4	3	2	1
TEMP								LSB	DP						LSB

bits-16/9	(TEMP)	Air temperature in two's complement
bit-9	(LSB)	0.5 °C
bits-8/1	(DP)	Dew Point in two's complement
bit-1	(LSB)	0.5 °C

**NOTE** - The temperatures in Subfield #10 are encoded in two's complement form to be able to distinguish between temperatures in the range of  $-0.4^{\circ}\text{C}$  to  $-0.1^{\circ}\text{C}$  shall be encoded as negative zero, while temperatures in the range of  $0.0^{\circ}$  to  $0.4^{\circ}\text{C}$  shall be encoded as positive zero.

**Structure of Subitem #11 of Data Item I237/240: Atmospheric Pressure**

Octet no. 1								Octet no. 2							
16	15	14	13	12	11	10	9	8	7	6	5	4	3	2	1
QNH														LSB	

bits-16/1	(QNH)	QNH
bit-1	(LSB)	1 hPa

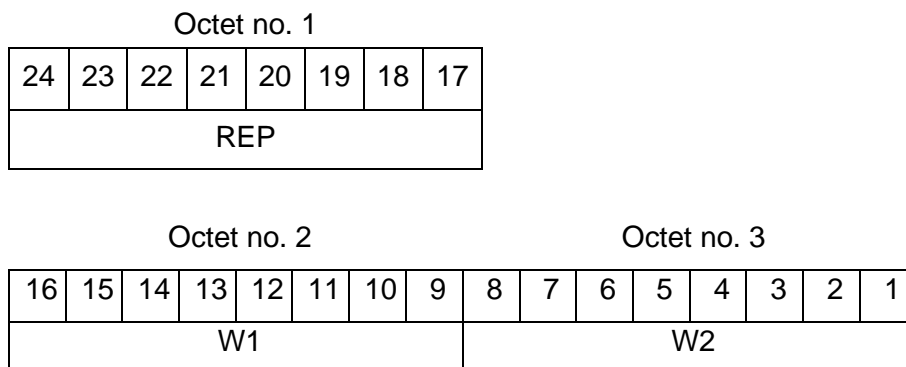
**Structure of Subitem #12 of Data Item I237/240: Recent Weather**

bits-24/17            (REP)            Number of weather codes for recent weather

bits-16/9            (W1)            Weather code/intensity letter 1  
ASCII Character (A–Z)

bits-8/1            (W2)            Weather code/intensity letter 2  
ASCII Character (A–Z)

**NOTE** - Types, characteristics, intensity and proximity of present weather are encoded in weather code letters. The codes for weather intensity are LI (light) and HE (heavy). The code “RE” for recent weather shall not be encoded as this subitem only contains reports on recent weather.

**NOTE** - The weather codes can be found in the ICAO Doc. 8896 [4]

**NOTE** - Example: The weather code “FG” means Fog

**Structure of Subitem #13 of Data Item I237/240: Wind Shear**

Octet no. 1															
24	23	22	21	20	19	18	17								
REP															
Octet no. 2								Octet no. 3							
16	15	14	13	12	11	10	9	8	7	6	5	4	3	2	1
RWN						RWD		WS		TL		0	0	0	0

bits-24/17	(REP)	Number of reported runways
bits-16/11	(RWN)	Runway number (1...36) (note 1)
bits-10/9	(RWD)	Runway designator =0 Not available (e. g. for single runway) =1 Left =2 Right =3 Centre
bits-8/7	(WS)	Wind shear =0 Wind shear on reported runway =1 Wind shear on all runways in same direction =2 Wind shear on all runways (note 2) =3 Reserved for future use
bits-6/5	(TL)	Purpose (take-off/landing) =0 not specified =1 TKOF (while take-off) =2 LDG (while landing) =3 Reserved for future use
bits-4/1	(Spare)	Spare bits, set to 0

**NOTE** - 1. RWN = 0 means all runways and REP should be 1.

**NOTE** - 2. If WS = 10, RWN and RWD are meaningless and shall be set to 0.

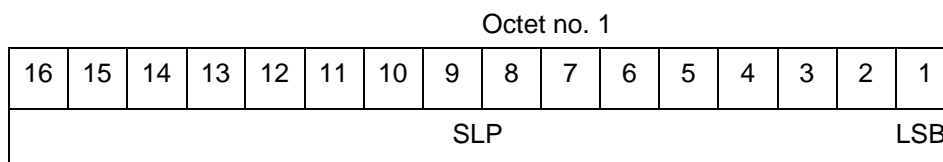
**Structure of Subitem #14 of Data Item I237/240: Sea Level Pressure**

bits-16/1	(SLP)	Sea level pressure (0...6553,5 hPa)
bit-1	(LSB)	0.1 hPa

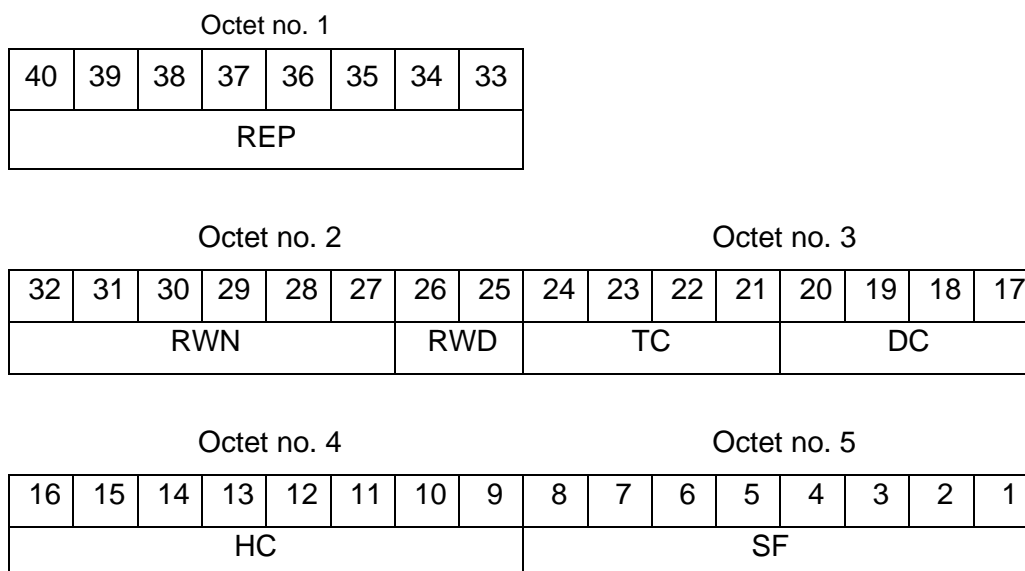
**Structure of Subitem #15 of Data Item I237/240: State of Runway**

bits-40/33	(REP)	Number of reported runways
bits-32/27	(RWN)	Runway number (1...36)
bits-26/25	(RWD)	Runway designator
		=0 Not available (e. g. for single runway)
		=1 Left
		=2 Right
		=3 Centre
bits-24/21	(TC)	Type of coverage (0...9)

bits-20/17	(DC)	Dimension of coverage (0...9)
bits-16/9	(HC)	Height of Coverage (0...99)
bits-8/1	(SF)	Friction coefficient and breaking action (0...99)

**NOTE** - If TC is set to max, the type of coverage is not specified or unavailable.

**NOTE** - If DC is set to max, the dimension of coverage is not specified or unavailable.

**NOTE** - If HC is set to max, the height of coverage is not measured.

**NOTE** - If SF is set to max, the runway is not in use.

**NOTE** - The equivalents to the numbers set in this item can be found in the ICAO Doc. 8896 [4].



**Structure of Subitem #16 of Data Item I237/240: Previsions**

Octet no. 1

128	127	126	125	124	123	122	121
REP							

Octet no. 2

120	119	118	117	116	115	114	113
Type		TM1					

Octet no. 3

Octet no. 4

112	111	110	109	108	107	106	105	104	103	102	101	100	99	98	97
TM1						LSB	TM2								

Octet no. 5

Octet no. 6

96	95	94	93	92	91	90	89	88	87	86	85	84	83	82	81
TM2	LSB	0	0	0	0	VIS								LSB	

Octet no. 7

Octet no. 8

80	79	78	77	76	75	74	73	72	71	70	69	68	67	66	65
DIR								WS							

Octet no. 9

Octet no. 10

64	63	62	61	60	59	58	57	56	55	54	53	52	51	50	49
VV				HCB								LSB	NRW		

Octet no. 11

Octet no. 12

48	47	46	45	44	43	42	41	40	39	38	37	36	35	34	33
W11								W12							

Octet no. 13

Octet no. 14

32	31	30	29	28	27	26	25	24	23	22	21	20	19	18	17
W21								W22							

Octet no. 15								Octet no. 16							
16	15	14	13	12	11	10	9	8	7	6	5	4	3	2	1
W31								W33							

bits-128/121	(REP)	Number of reported previsions
bits-120/118	(Type)	Type of prevision =0 NOSIG =1 BECMG =2 TEMPO =3 SNOCLO =4-7 Reserved
bits-117/106	(TM1)	At time
bit-117	(TM1#EP)	Element Populated Bit =0 TM1 not populated =1 TM1 populated
bits-116/106	(TM1#VAL)	At time (1 min ...1440 min) (note)
bit-106	(LSB)	1 min
bits-105/94	(TM2)	From time
bit-105	(TM2#EP)	Element Populated Bit =0 TM2 not populated =1 TM2 populated
bits-104/94	(TM2#VAL)	From time (1 min ...1440 min) (note)
bit-94	(LSB)	1 min
bits-93/90	(Spare)	Spare bits, set to 0
bits-89/81	(VIS)	Visibility
bit-89	(VIS#EP)	Element Populated Bit =0 VSP not populated =1 VSP populated
bits-88/81	(VIS#VAL)	Visibility (0 m...12500 m)
bit-81	(LSB)	50 m

---

bits-80/73	(DIR)	Direction
bit-80	(DIR#EP)	Element Populated Bit =0 DIR not populated =1 DIR populated
bits-79/73	(DIR#VAL)	Direction (10°... 360°)
bit-73	(LSB)	10°
bits-72/65	(WS)	Wind speed
bit-72	(WS#EP)	Element Populated Bit =0 WS not populated =1 WS populated
bits-71/65	(WS#VAL)	Wind speed (0 kn...127 kn)
bit-65	(LSB)	1 kn
bits-64/60	(VV)	Vertical Visibility
bit-64	(VV#EP)	Element Populated Bit =0 VV not populated =1 VV populated
bits-63/60	(VV#VAL)	Vertical visibility values =0 No indication =1 No cloud detected (NCD) =2 Sky clear (SKC) =3 Sky clear from automated station (CLR) =4 No significant cloud (NSC) =5 Clouds and visibility OK (CAVOK) =6 FEW (1–2 octas) =7 SCT (3–4 octas) =8 BKN (5–7 octas) =9 OVC (8 octas) =10 Lack of cloud data =11-14 Reserved for future use =15 Vertical visibility

---

bits-59/51	(HCB)	Height of cloud base
bit-59	(HCB#EP)	Element Populated Bit =0 HCB not populated =1 HCB populated
bits-58/51	(HCB#VAL)	Height of cloud base (0 ft...1600 ft)
bit-51	(LSB)	100 ft
bits-50/49	(NRW)	= Amount of weather codes (0-3)
bits-48/41	(W11)	Weather code 1 letter 1 ASCII Character (A-Z)
bits-40/33	(W12)	Weather code 1 letter 2 ASCII Character (A-Z)
bits-32/25	(W21)	Weather code 2 letter 1 ASCII Character (A-Z)
bits-24/17	(W22)	Weather code 2 letter 2 ASCII Character (A-Z)
bits-16/9	(W31)	Weather code 3 letter 1 ASCII Character (A-Z)
bits-8/1	(W32)	Weather code 3 letter 2 ASCII Character (A-Z)

**Encoding Rule:** See Table 1 and Table 2

**NOTE** - If there is only TM1 present, it's an AT time. If there are TM1 and TM2 present, they are FROM and UNTIL times

**NOTE** - For weather codes see ICAO Doc. 8896 [4] or METAR Explanation [12]

### 5.1.29 Data Item I237/250, Minimum QNH Forecast

**Definition:** Minimum QNH values to be expected.

**Format:** Repetitive Data Item comprised of a one-octet Field Repetition Indicator (REP) followed by at least two-octet minimum QNH forecast.

**Structure:**

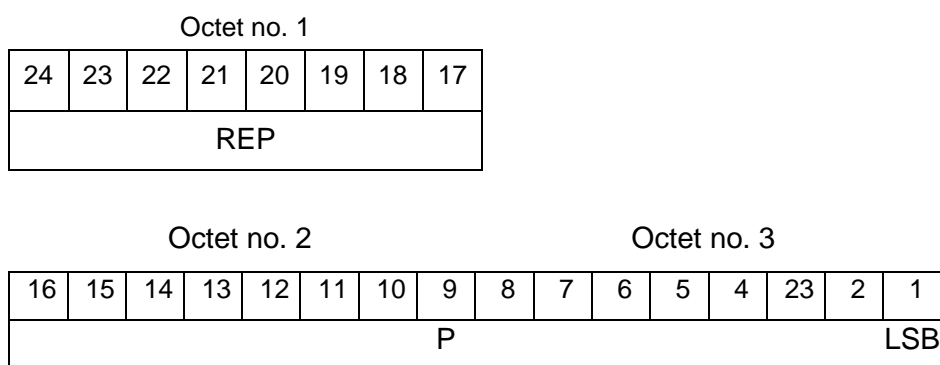

bits-24/17	(REP)	Number of areas being reported.
bits-16/1	(P)	Min. QNH forecast in area in hPa
bit-1	(LSB)	1 hPa

**Encoding Rule:**

See Table 1 and Table 2

**NOTE** - Each repetition defines the min. QNH forecast for one predefined Area. The predefined areas can be found in the min QNH forecast rules for each country. An example can be found in ICAO Doc. 8896 [4].

### 5.1.30 Data Item I237/260, Message Identification

**Definition:** Identification of a unique message.

**Format:** Eight-octet fixed length Data Item.

**Structure:**

Octet no. 1								Octet no. 2							
64	63	62	61	60	59	58	57	56	55	54	53	52	51	50	49
CHAR1								CHAR2							
ID															

Octet no. 3								Octet no. 4							
48	47	46	45	44	43	42	41	40	39	38	37	36	35	34	33
CHAR3								CHAR4							
ID (cont.)															

Octet no. 5								Octet no. 6							
32	31	30	29	28	27	26	25	24	23	22	21	20	19	18	17
CHAR5								CHAR6							
ID (cont.)															

Octet no. 7								Octet no. 8							
16	15	14	13	12	11	10	9	8	7	6	5	4	3	2	1
CHAR7								CHAR8							
ID (cont.)															

bits-64/1            (ID)            ID of the Message consisting of 8  
ASCII Characters (A–Z, 0–9) or 0 as  
Bit. (CHAR1 – CHAR8)

**Encoding Rule:**

See Table 1 and Table 2

- NOTE** - 1. The message identification number is to be used to uniquely identify each message. If messages are being sent on redundant links, then this number shall be identical for the message on each link. This will allow the receiver to easily identify and discard duplicate messages.
- NOTE** - 2. It is not required that message identification numbers are assigned in ascending order by time of message transmission.
- NOTE** - 3. This Data Item is optional. When used, it shall be transmitted only if different from zero and shall be described in the ICD of the system generating the Category 237 message.
- NOTE** - 4. If a CHAR is not relevant it shall be set to "0" as bit.

## 5.2 Transmission of Aeronautical Data Messages

### 5.2.1 Standard user application profile

The following user application profile shall be used for the transmission of aeronautical data messages.

**Table 3 – Aeronautical data messages UAP**

FRN	Data Item	Information	Length
1	I237/010	Data Source Identification	2
2	I237/000	Message Type	1
3	I237/011	Local Data Source Identifier	1
4	I237/015	Service Identification	1
5	I237/020	Message Category	1
6	I237/030	Error Codes	1+
7	I237/040	Time of Filing	4
FX	n.a.	Field extension indicator	n.a.
8	I237/050	Message Originator Address	8
9	I237/060	Message Destination Address	8
10	I237/070	Message Header	4
11	I237/080	Message to be replaced	4
12	I237/090	NOTAM qualifier Q: Flight Information Region	4
13	I237/100	NOTAM qualifier Q: NOTAM Code	4
14	I237/110	NOTAM qualifier Q: Traffic, Purpose, Scope	2
FX	n.a.	Field extension indicator	n.a.
15	I237/120	NOTAM qualifier Q: Vertical Limits & Geographical Reference	10
16	I237/130	Location Indicator	1+4*n
17	I237/140	Message Activation Time	4
18	I237/150	Message Cancellation Time	5
19	I237/160	Day/Time Schedule of actual Activity	1+1*n
20	I237/170	Free Text	1+1*n
21	I237/180	Lower and Upper Limit	5
FX	n.a.	Field extension indicator	n.a.
22	I237/190	SNOWTAM: Runway Conditions	1+14*n
23	I237/195	SNOWTAM: Friction Measurement Method	1+1*n
24	I237/200	SNOWTAM: Taxiway Conditions	1+3*n
25	I237/210	SNOWTAM: Apron Conditions	1+5*n
26	I237/220	ASHTAM	1+
27	I237/230	BIRDTAM	1+7*n
28	I237/240	METAR/SPECI	1+
FX	n.a.	Field extension indicator	n.a.



---

FRN	Data Item	Information	Length
29	I237/250	Minimum QNH Forecast	1+2*n
30	I237/260	Message Identification	8
31	SP-Data Item	Special Purpose Field	1+1+
32	-	Not used	-
33	-	Not used	-
34	-	Not used	-
35	-	Not used	-
FX	n.a.	Field extension indicator	n.a.

In the above table,

- the first column indicates the field reference number (FRN) associated to each Data Item used in the UAP.
- the fourth column gives the format and the length of each item:  
A stand-alone figure indicates the octet-count of a fixed-length Data Item,  
1+x indicates a variable-length Data Item comprising a first part of 1 octet followed by n-octets extensions as necessary.



SUPPORTING  
EUROPEAN  
AVIATION

© EUROCONTROL - April 2025

This document is published by EUROCONTROL for information purposes. It may be copied in whole or in part, provided that EUROCONTROL is mentioned as the source and it is not used for commercial purposes (i.e. for financial gain). The information in this document may not be modified without prior written permission from EUROCONTROL.

[www.eurocontrol.int](http://www.eurocontrol.int)